

INDEX

Module	Contents	Page
I	QUANTUM MECHANICS	1 - 18
II	ELECTRONIC MATERIALS AND SEMICONDUCTORS	19 - 39
III	LIGHT-SEMICONDUCTOR INTERACTION	40 – 57
IV	ENGINEERED ELECTRIC AND MAGNETIC MATERIALS	58 – 83
V	LASERS AND FIBER OPTICS	84 - 98

MODULE-I

PRINCIPLES OF QUANTUM MECHANICS

Introduction

At the end of nineteenth century, physicists had every reason to regard the Newtonian laws governing the motion of material bodies and Maxwell's laws of electromagnetism, as fundamental laws of physics. They believed that there should be some limitation on the validity of these laws which constitute classical mechanics. To understand the submicroscopic world of the atom and its constituents, it became necessary to introduce new ideas and concepts which led to which led to the mathematical formulation of quantum mechanics. That had an immediate and spectacular success in the explanation of the experimental observations.

Quantum mechanics is the science of the submicroscopic. It explains the behavior of matter and its interactions with energy on the scale of atoms and its constituents.

Light behaves in some aspects like particles and in other aspects like waves. Quantum mechanics shows that light, along with all other forms of electromagnetic radiation, comes in discrete units, called photons, and predicts its energies, colors, and spectral intensities. A single photon is a quantum, or smallest observable amount, of the electromagnetic field because a partial photon has never been observed.

Considering the above facts, it appears difficult to accept the conflicting ideas that radiation has a dual nature, i.e., radiation is a wave which is spread out over space and also a particle which is localized at a point in space. However, this acceptance is essential because radiation sometimes behaves as a wave and at other times as a particle as explained below:

(1) Radiations including visible light, infra-red, ultraviolet, X-rays, etc. behave as waves in experiments based on interference, diffraction, etc. This is due to the fact that these phenomena require the presence of two waves at the same position at the same time. Obviously, it is difficult for the two particles to occupy the same position at the same time. Thus, we conclude that radiations behave like wave..

(2) Planck's quantum theory was successful in explaining black body radiation, the photo electric effect, the Compton Effect, etc. and had clearly established that the radiant energy, in its interaction with matter, behaves as though it consists of corpuscles. Here radiation interacts with matter in the form of photon or quanta. Thus, we conclude that radiations behave like particle.

Black body radiation

A body that completely absorbs all waves lengths of radiation incident on it at low temperatures or emits different wave lengths of radiation at higher temperatures is known as a black body.

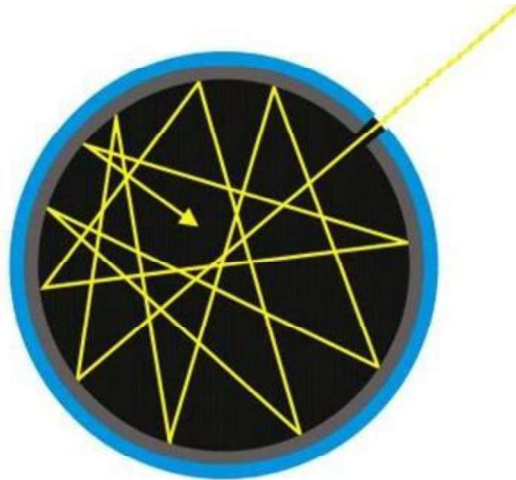

Figure Black body

An approximate realization of a black surface is a hole in the wall of a large enclosure. Any light entering the hole is reflected within the internal surface of the body indefinitely or absorbed within the body and is unlikely to re-emerge, making the hole a nearly perfect absorber. The radiation confined in such an enclosure may or may not be in thermal equilibrium, depending upon the nature of the walls and the other contents of the enclosure.

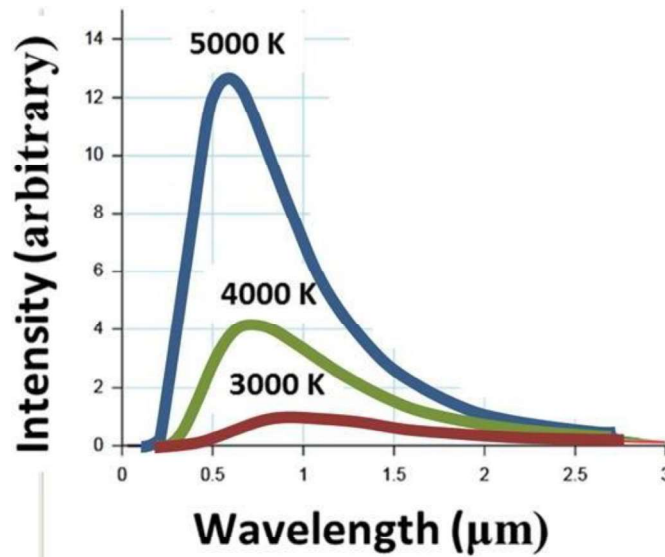

Figure Black body radiation distribution

Plank's law

Plank assumed that the walls of the black body consist of large number of electrical oscillators, vibrating with their own natural frequencies. An oscillator possesses an energy equal to $h\nu$. Where h is Planks constant and ν is the frequency of oscillator.

An oscillator may lose or gain energy by emitting or by absorbing photons respectively. Plank derived an equation for the energy per unit volume of black body in the entire spectrum of black body radiation. The spectral radiance of a body, B_ν , describes the amount of energy it gives

off as radiation of different frequencies. It is measured in terms of the power emitted per unit area of the body, per unit solid angle that the radiation is measured over, per unit frequency. Planck showed that the spectral radiance of a body for frequency ν at absolute temperature T is given by

$$E(\lambda, T) = \frac{2\pi^2 c^2}{\lambda^5} * \frac{1}{\exp \frac{hc}{\lambda k T}} \text{-----(1)}$$

Where k is the Boltzmann constant, h is the Planck constant, and c is the speed of light in the medium, whether material or vacuum. The spectral radiance can also be expressed per unit wavelength λ instead of per unit frequency.

Photoelectric effect

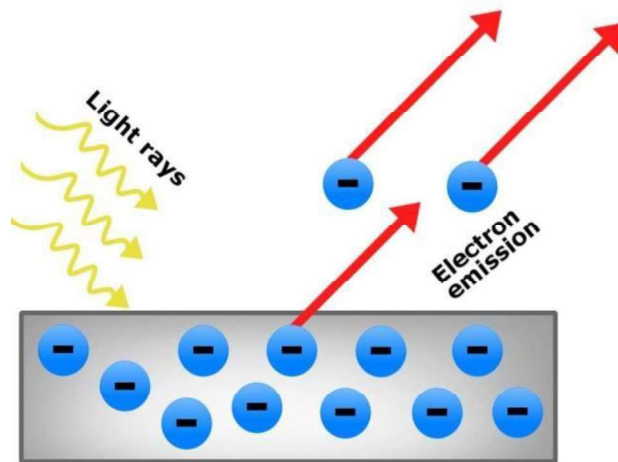

Figure Photoelectric effect

The photoelectric effect is the emission of electrons or other free carriers when light shines on a material. Electrons emitted in this manner can be called photo electrons. This phenomenon is commonly studied in electronic physics, as well as in fields of chemistry, such as quantum chemistry or electrochemistry.

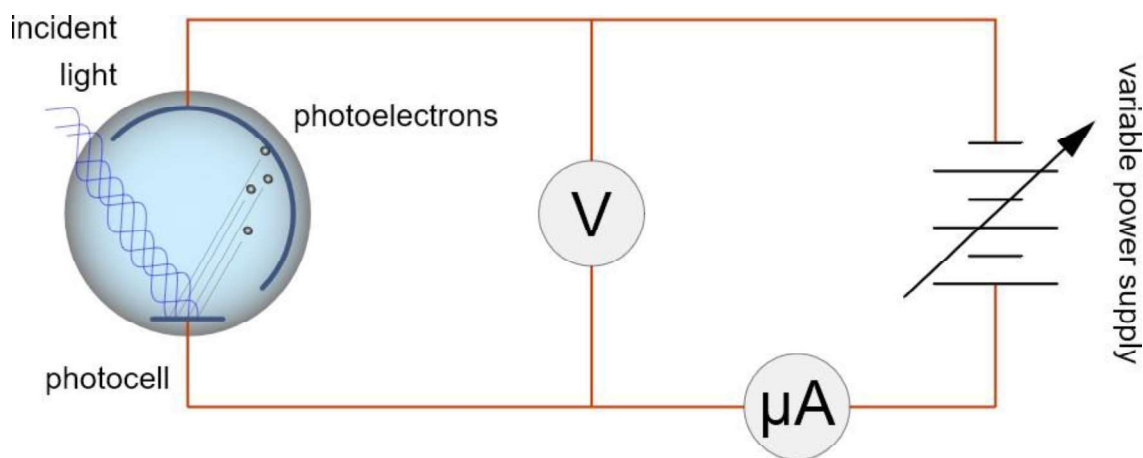

Figure Black diagram of Photo electric effect

Einstein assumed that a photon would penetrate the material and transfer its energy to an electron. As the electron moved through the metal at high speed and finally emerged from the material, its kinetic energy would diminish by an amount ϕ called the work function (similar to the electronic work function), which represents the energy required for the electron to escape the metal. By conservation of energy, this reasoning led Einstein to the photoelectric equation $E_k = hf - \phi$, where E_k is the maximum kinetic energy of the ejected electron.

Compton Effect

The scattering of a photon by a charged particle like an electron. It results in a decrease in energy of the photon called the Compton Effect. Part of the energy of the photon is transferred to the recoiling electron.

The interaction between an electron and a photon results in the electron being given part of the energy (making it recoil), and a photon of the remaining energy being emitted in a different direction from the original, so that the overall momentum of the system is also conserved. If the scattered photon still has enough energy, the process may be repeated. In this scenario, the electron is treated as free or loosely bound.

Compton derived the mathematical relationship between the shift in wavelength and the scattering angle of the X-rays by assuming that each scattered X-ray photon interacted with only one electron. His paper concludes by reporting on experiments which verified his derived relation:

$$(\lambda^1 - \lambda) = \frac{h}{m_o c} (1 - \cos \theta) \text{ -----(2)}$$

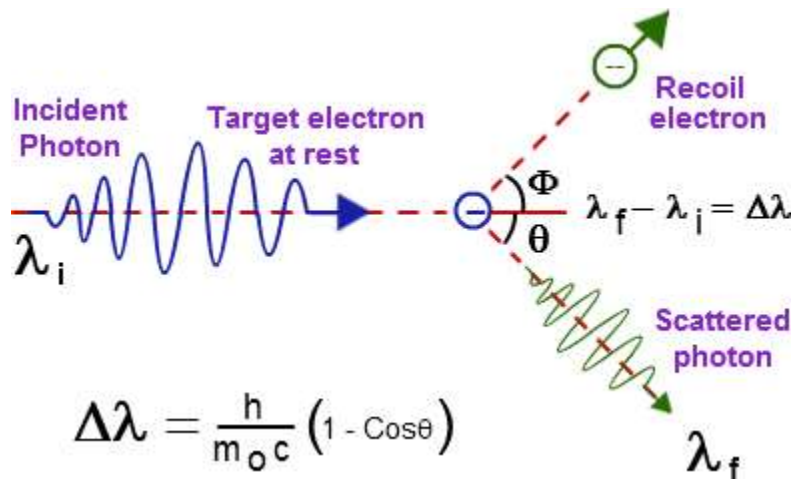

Figure Compton Effect

de- Broglie Hypothesis

In quantum mechanics, matter is believed to behave both like a particle and a wave at the sub-microscopic level. The particle behavior of matter is obvious. When you look at a table, you think of it like a solid, stationary piece of matter with a fixed location. At this macroscopic scale, this holds true. But when we zoom into the subatomic level, things begin to get more complicated, and matter doesn't always exhibit the particle behavior that we expect.

This non-particle behavior of matter was first proposed in 1923, by Louis de Broglie, a French physicist. In his PhD thesis, he proposed that particles also have wave-like properties. Although he did not have the ability to test this hypothesis at the time, he derived an equation to prove it using Einstein's famous mass-energy relation and the Planck equation. These waves associated with particles are named de- Broglie waves or matter waves.

Expression for de- Broglie wavelength

The expression of the wavelength associated with a material particle can be derived on the analogy of radiation as follows:

Considering the plank's theory of radiation, the energy of photon (quantum) is

$$E = h\nu = \frac{hc}{\lambda} \rightarrow (3)$$

Where c is the velocity of light in vacuum and λ is its wave length.

According to Einstein energy – mass relation

$$E = mc^2 \rightarrow (4)$$

$$\lambda = \frac{hc}{mc} = \frac{hc}{p} \rightarrow (5)$$

Where $mc = p$ is momentum associated with photon.

If we consider the case of material particle of mass m and moving with a velocity v , i.e momentum mv , then the wave length associated with this particle (in analogy to wave length associated with photon) is given by

$$\lambda = \frac{h}{mv} = \frac{h}{p} \rightarrow (6)$$

Different expressions for de-Broglie wavelength

(a) If E is the kinetic energy of the material particle then

$$E = \frac{1}{2}mv^2 = \frac{1}{2} \frac{m^2 v^2}{m} = \frac{p^2}{2m}$$

$$\Rightarrow p^2 = 2mE \text{ or } p = \sqrt{2mE}$$

Therefore de-Broglie wave length $\lambda = \frac{h}{\sqrt{2mE}} \rightarrow (7)$

(b) When a charged particle carrying a charge „q“ is accelerated by potential difference V, then its kinetic energy K .E is given by

$$E = qV$$

Hence the de-Broglie wavelength associated with this particle is

$$\lambda = \frac{h}{\sqrt{2mqV}} \rightarrow (8)$$

For an electron $q = 1.602 \times 10^{-19}$

Mass $m = 9.1 \times 10^{-31}$ kg

$$\therefore \lambda = \frac{6.626 \times 10^{-34}}{\sqrt{2 \times 9.1 \times 10^{-31} \times 1.602 \times 10^{-19} V}}$$

$$= \frac{150}{\sqrt{V}} = \frac{12.26}{\sqrt{V}} \text{ \AA} \rightarrow (9)$$

Properties of Matter Waves

Following are the properties of matter waves:

- Lighter is the particle, greater is the wavelength associated with it.
- Smaller is the velocity of the particle, greater is the wavelength associated with it.
- When $v = 0$, then $\lambda = \infty$, i.e. wave becomes indeterminate and if $v = \infty$ then $\lambda = 0$. This shows that matter waves are generated only when material particles are in motion.
- Matter waves are produced whether the particles are charged particles or not ($\lambda = \frac{h}{mv}$ is independent of charge). i.e., matter waves are not electromagnetic waves but they are a new kind of waves .
- It can be shown that the matter waves can travel faster than light i.e. the velocity of matter waves can be greater than the velocity of light.
- No single phenomenon exhibits both particle nature and wave nature simultaneously.

Distinction between matter waves and electromagnetic waves

S.No	Matter Waves	Electromagnetic Waves
1	Matter waves are associated with moving particles (charged or uncharged)	Electromagnetic waves are produced only by accelerated charged particles.
2	Wavelength depends on the mass of the particle and its velocity, $\lambda = \frac{h}{mv}$	Wavelength depends on the energy of photon
3	Matter waves can travel with a velocity greater than the velocity of light. Matter wave is not electromagnetic wave.	Travel with velocity of light $c = 3 \times 10^8$ m/s
4.	Matter wave require medium for propagation, i.e, they cannot travel through vacuum.	Electric field and magnetic field oscillate perpendicular to each other.
5.		Electromagnetic waves do not require any medium for propagation, i.e., they can pass through vacuum.

Davisson and Germer's Experiment

The first experimental evidence of matter waves was given by two American physicists, Davisson and Germer in 1927. The experimental arrangement is shown in figure 3.1(a).

The apparatus consists of an electron gun G where the electrons are produced. When the filament of electron gun is heated to dull red electrons are emitted due to thermionic emissions. Now, the electrons are accelerated in the electric field of known potential difference. These electrons are collimated by suitable slits to obtain a fine beam which is then directed to fall on a large single crystal of nickel, known as target T which is rotated about an angle along the direction of the beam is detected by an electron detector (Faraday cylinder) which is connected to a galvanometer. The Faraday cylinder „c“ can move on a circular graduated scale s between 29° to 90° to receive the scattered electrons.

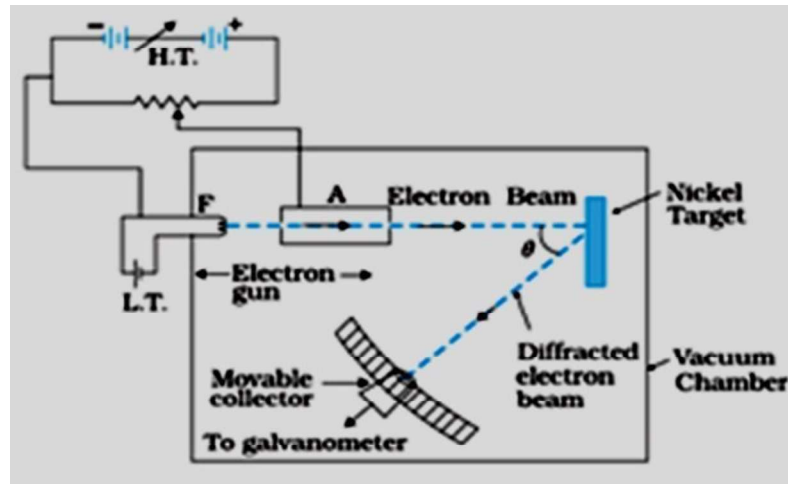

Figure 6 Davisson and Germer's experimental arrangement for verification of matter waves

First of all, the accelerating potential V is given a low value and the crystal is set at any orbital azimuth (θ). Now the Faraday cylinder is moved to various positions on the scale "s" and galvanometer current is measured for each position. A graph is plotted between galvanometer current against angle θ between incident beam and beam entering the cylinder [Figure 3.1(b)]. The observations are repeated for different acceleration potentials.

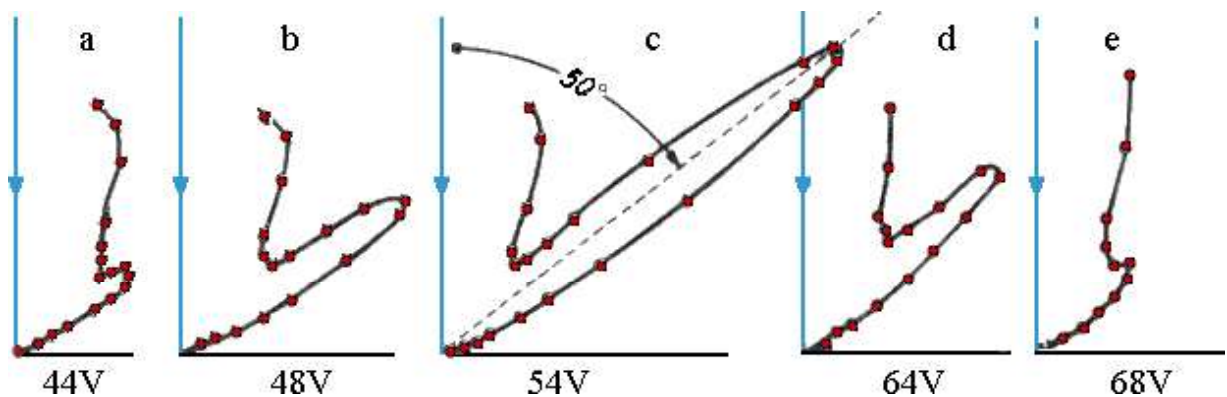

Figure 7 Variation of Galvanometer current with variation of angle θ between incident beam and beam entering the cylinder

It is observed that a „bump“ begins to appear in the curve for 44 volts. Following points are observed.

- With increasing potential, the bump moves upwards.
- The bump becomes most prominent in the curve for 54 volts at $\theta = 50^\circ$.
- At higher potentials, the bumps gradually disappear.

The bump in its most prominent state verifies the existence of electron waves. According to de- Broglie, the wavelength associated with electron accelerated through a potential V is given by

$$\lambda = \frac{12.26}{\sqrt{V}} \text{ \AA}.$$

Hence, the wavelength associated with an electron accelerated through 54 volt is

$$\lambda = \frac{12.26}{\sqrt{54}} = 1.67 \text{ \AA}$$

From X-ray analysis, it is known that a nickel crystal acts as a plane diffraction grating with space $d = 0.91 \text{ \AA}$ [see Figure 3.1(c)]. According to experiment, we have diffracted electron beam at $\theta = 50^\circ$. The corresponding angle of incidence relative to the family of Braggplane

$$\theta^i = \frac{180 - 50}{2} = 65^\circ$$

Using Bragg's equation (taking $n=1$), we have

$$\begin{aligned} \lambda &= 2d\sin\theta \\ &= 2(0.91\text{\AA}) \sin 65^\circ \end{aligned}$$

This is in good agreement with the wavelength computed from de-Broglie hypothesis.

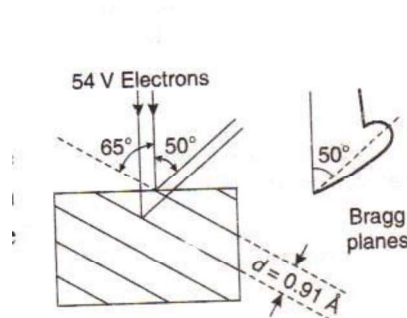

Figure 8 Bragg planes in Nickel crystal

As the two values are in good agreement, hence, confirms the de-Broglie concept of matter waves.

Schrodinger's time independent wave equation

Schrodinger developed a differential equation whose solutions yield the possible wave functions that can be associated with a particle in a given situation. This equation is popularly known as Schrodinger equation. The equation tells us how the wave function changes as a result of forces acting on the particle. One of its forms can be derived by simply incorporating the de-Broglie wavelength expression into the classical wave equation.

If a particle of mass „m“ moving with velocity v is associated with a group of waves, let ψ be the wave function of the particle. Also let us consider a simple form of progressing wave represented by the equation

$$= \psi_0 \sin(\omega t - kx) \text{ ----- (1)}$$

Where $\psi = \psi(x, t)$

ψ_0 is amplitude

Differentiating eq (1) partially with respect to „x“, we get

$$\frac{\partial \psi}{\partial x} = -K \psi_0 \cos(\omega t - kx)$$

Again differentiating equation (1) with respect to „x“

$$\frac{\partial^2 \psi}{\partial x^2} = -K^2 \psi_0 \sin(\omega t - kx)$$

$$\frac{\partial^2 \psi}{\partial x^2} = -k^2 \psi$$

$$\frac{\partial^2 \psi}{\partial x^2} + k^2 \psi = 0 \text{-----(2)}$$

$$\text{Since } k = \frac{2\pi}{\lambda}, \quad \frac{\partial^2 \psi}{\partial x^2} + \frac{4\pi^2}{\lambda^2} \psi = 0 \text{-----(3)}$$

Eq (2) or Eq (3) is the differential form of the classical wave equation. Now, incorporating de-Broglie wavelength expression $\lambda = \frac{h}{mv}$ in to eq (3), we get

$$\frac{\partial^2 \psi}{\partial x^2} + \frac{4\pi^2 m^2 v^2}{h^2} \psi = 0 \quad \rightarrow (4)$$

The total energy E of the particle is the sum of its kinetic energy k and potential energy V

$$\text{i.e., } E = K + V$$

$$\text{But } K = \frac{1}{2}mv^2$$

$$\therefore E = \frac{1}{2}mv^2 + V$$

$$\frac{1}{2}mv^2 = E - V$$

$$m^2v^2 = 2m(E - V) \quad \rightarrow (5)$$

Substituting eq (5) in eq (4), we get

$$\frac{\partial^2 \psi}{\partial x^2} + \frac{8\pi^2 m(E - V)}{h^2} \psi = 0 \quad \rightarrow (6)$$

In quantum mechanics, the value $\frac{h}{2\pi}$ occurs most frequently. Hence we denote $\hbar = \frac{h}{2\pi}$

using this notation, we have

$$\frac{\partial^2 \psi}{\partial x^2} + \frac{2m(E - V)}{\hbar^2} \psi = 0 \quad \rightarrow (7)$$

For simplicity, we have considered only one dimensional wave extending eq(7) for a 3 – dimensional wave

$$\frac{\partial^2 \psi}{\partial x^2} + \frac{\partial^2 \psi}{\partial y^2} + \frac{\partial^2 \psi}{\partial z^2} + \frac{2m(E - V)}{\hbar^2} \psi = 0 \quad \rightarrow (8)$$

Where $\psi(x, y, z)$; here, we have considered only stationary states of ψ after separating the time dependence of ψ

The Laplacian operator is defined as

$$\nabla^2 = \frac{\partial^2}{\partial x^2} + \frac{\partial^2}{\partial y^2} + \frac{\partial^2}{\partial z^2} \quad \rightarrow (9)$$

Hence eq (10) can be written as

$$\nabla^2 \psi + \frac{2m(E - V)}{\hbar^2} \psi = 0 \quad \rightarrow (10)$$

This is Schrodinger wave equation. Since time factor doesn't appear, eq(8) or eq(10) is called „time independent Schrodinger wave equation“ in three dimensions.

Physical significance of wave function ψ

- (1) The wave function ψ has no direct physical meaning. It is a complex quantity representing the variation of matter wave.
- (2) It connects the practical nature and its associated wave nature statically.
- (3) $|\psi|^2$ (or $\psi\psi^*$ if function is complex) at a point is proportional to the probability of finding the particle at that point at any given time. The probability density at any point is represented by $|\psi|^2$.
- (4) If the particle is present in a volume $dxdydz$, then $|\psi|^2 dxdydz = 1$

If a particle is present somewhere in space

$$\int_{-\infty}^{\infty} \psi^2 dx dy dz = 1$$

$$\text{Or } \int_{-\infty}^{\infty} \psi\psi^* dx dy dz = 1$$

The wave function satisfying the above condition is said to be normalized.

Particle in Infinite square potential well

A free electron trapped in a metal or charge carriers trapped by barriers trapped by the potential barriers of a double hetero junction can be approximated by an electron in an infinitely deep one- dimensional potential well.

Consider one – dimensional potential well of width L as shown in fig. Let the potential $V = 0$ inside well and $V = \infty$ outside the well.

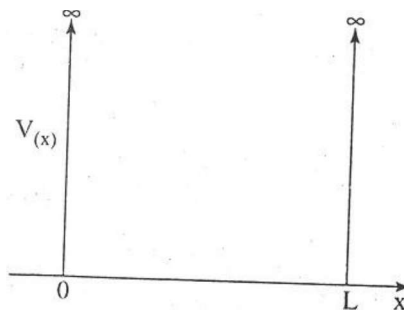

Fig.4.4 Square potential well infinite height

The time independent Schrödinger wave equation in one dimensional case

$$\frac{d^2 \psi}{dx^2} + \frac{2m(E - V)}{\hbar^2} \psi = 0 \quad \rightarrow (1)$$

For a particle present inside the well where $V=0$ and $\psi = \psi(x)$

$$\frac{d^2\psi}{dx^2} + \frac{2mE}{\hbar^2} \psi = 0 \quad \rightarrow (2)$$

Let the general solution of eq (2) be

$$\psi(x) = A \sin kx + B \cos kx \quad \rightarrow (3)$$

Where A and B are constants which can be determined from boundary conditions

$$\psi(x) = 0 \text{ at } x = 0$$

$$\text{And } \psi(x) = 0 \text{ at } x = L \quad \rightarrow (4)$$

$$\text{Since } \psi(x) = 0 \text{ at } x = 0 \\ 0 = A \sin(0) + B \cos(0)$$

$$\Rightarrow B = 0 \quad \rightarrow (5)$$

$$\text{Since } \psi(x) = 0 \text{ at } x = L \\ 0 = A \sin kL$$

Which means $A=0$ or $\sin kL = 0$ since both A and B cannot be zero, $A \neq 0$. If $A = 0$, then $\psi = 0$ everywhere. This means that the particle is not in the well. The only meaningful way to satisfy the condition is

$$\sin kL = 0, \\ \text{or } kL = n\pi ; n = 1, 2, 3, \dots \\ \therefore k = \frac{n\pi}{L} \quad \rightarrow (6)$$

Thus, eq (3) simplifies to

$$\psi(x) = A \sin \frac{n\pi}{L} x \quad \rightarrow (7)$$

Differentiating ψ in eq (7)

$$\frac{d\psi}{dx} = A \frac{n\pi}{L} \cos \frac{n\pi}{L} x$$

Again Differentiating, we get

$$\frac{d^2\psi}{dx^2} = -A \frac{n^2\pi^2}{L^2} \sin \frac{n\pi}{L} x$$

$$\frac{d^2\psi}{dx^2} = -\frac{n^2\pi^2}{L^2} \psi = 0$$

$$\frac{d^2\psi}{dx^2} + \frac{n^2\pi^2}{L^2} \psi = 0 \quad \rightarrow (8)$$

Comparing eq (2) and eq (8), we get

$$\frac{2mE}{\hbar^2} = \frac{n^2\pi^2}{L^2} = k^2$$

$$E = \frac{n^2\pi^2\hbar^2}{2mL^2}$$

n is called the quantum number. Thus we obtain an important result. The particle cannot possess any value of energy as assumed in classical case, but it possesses only discrete set of energy values.

The energy of the n^{th} quantum level,

$$E_n = \frac{n^2 \pi^2 \hbar^2}{2mL^2} = \frac{n^2 h^2}{8mL^2} \quad (\text{since } \hbar = \frac{h}{2\pi}) \quad \rightarrow (9)$$

The wave functions and the corresponding energy levels of the particles are as suggested in Figure 3.5

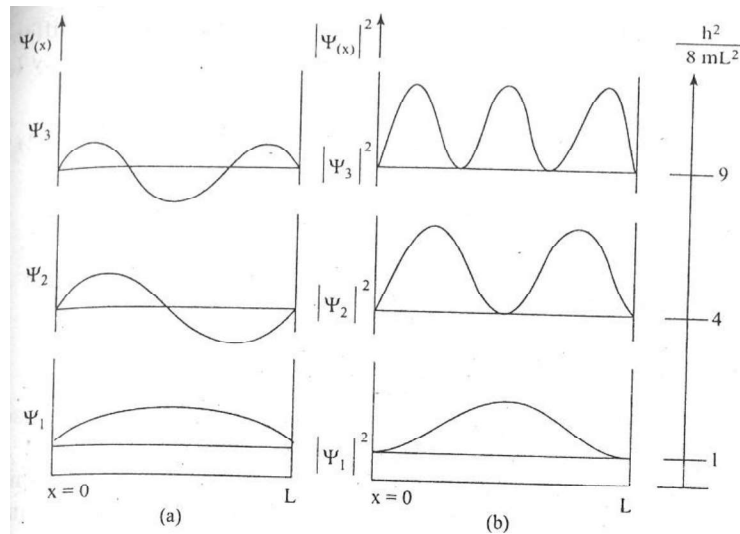

Fig.4.5 Ground state and first two excited states of an electron in a potential well: a) the electron wave functions and b) the corresponding probability density functions. The energies of these three states are shown on the right.

We are still left with an arbitrary constant „A“ in eq (7). It can be obtained by applying normalization condition i.e.; the probability of finding the particle inside the box is unity.

$$\int_0^L \psi^2 dx = 1$$

$$A^2 \int_0^L \sin^2 \frac{n\pi x}{L} dx = 1$$

$$A^2 \int_0^L \frac{1 - \cos \frac{2n\pi x}{L}}{2} dx = 1$$

$$\frac{A^2}{2} \left[x - \frac{L}{2\pi n} \sin \frac{2\pi n x}{L} \right]_0^L = 1$$

$$\Rightarrow \frac{A^2}{2} (L - 0 - 0 - 0) = 1$$

$$\frac{A^2 L}{2} = 1 \text{ or } A = \frac{2}{L} \quad \rightarrow (10)$$

∴ The normalized wave function is

$$\psi_n = \frac{2}{L} \sin \frac{n\pi x}{L} \quad \rightarrow (11)$$

Notice that the number of nodes (places where the particle has zero probability of being located) increases with increasing energy n. Also note that as the

energy of the particle becomes greater, the quantum mechanical model breaks down as the energy levels get closer together and overlap, forming a continuum.

This continuum means the particle is free and can have any energy value. At such high energies, the classical mechanical model is applied as the particle behaves more like a continuous wave. Therefore, the particle in a box problem is an example of Wave-Particle Duality.

MODULE-II

ELECTRONIC MATERIALS AND SEMICONDUCTORS

Introduction to Electron Theory of Solids

The electrons in the outermost orbital of the atom which constitute the solid, determine its electrical properties. On the basis of electrical properties, solid can be broadly classified into insulators, semi conductors and conductors. The electron theory of solids (which is applicable to all solids both metals and non metals) aims to explain the structures and properties of solids through their electronic structure. It explains the electrical, thermal and magnetic properties of solids. The theory has been developed in three main stages.

- i) The classical free electron theory (CFET)
- ii) The quantum free electron theory (QFET)
- iii) The Zone theory or Band theory of solids.

The classical free electron theory

This theory was proposed to account for the electrical conduction in metals by Drude in 1900. It was extended by H.A. Lorentz in 1909. This theory was also known as **Free electron theory of metals**.

Metal atoms have one or more loosely bound valence electrons. Such electrons get detached easily even with small thermal energy. The detached electrons are neither shared nor acquired by any of the atoms of the metal. Hence they are free and just form a common pool.

The electrostatic interaction of detached electrons with the positive ion cores and with other electrons is assumed to be negligible. A consequence of this assumption is that the detached electrons can move freely everywhere within the confinements of the metal piece. Hence these electrons are called as free electrons or conduction electrons. When an electric field is applied, free electrons will experience slow drift motion in the positive direction of the field and produce a current in the metal.

Successes of Classical Free Electron Theory

- 1) It proved the validity of ohms law
- 2) It could give a satisfactory explanation to the mechanism of electrical current in conductors and thermal conductivity of metals.
- 3) It explains optical properties of metals.

It derives the relation between electrical conductivity and thermal conductivity.

Failures:

- 1) Temperature dependence of resistivity of metals could not be established correctly.
- 2) Heat capacity and paramagnetic susceptibility of conduction electrons could not be explained successfully.
- 3) It could not predict correct values to the mean free path of electrons.

The electron quantum free theory

Sommerfeld developed this theory during 1928. He considered Drude's assumption on the free electrons as it is. In addition to that, he applied Pauli's exclusion principle to the electron gas and applied Fermi-Dirac statistics in place of Maxwell-Boltzmann statistics. The results of these modifications indicated that not all free electrons would contribute to the processes like electrical and thermal conductivities of metals. Rather only a small fraction of the free electron gas of the metal would participate in such properties.

Bloch's theorem

Crystalline solid consists of a lattice which is composed of a large number of ionic cores at regular intervals and the conduction electrons move throughout the lattice.

Let us consider the picture of the lattice in only one dimension, i.e., only an array of ionic cores along x-axis. If we plot the potential energy of a conduction electron as a position in the lattice, the variation of potential energy is as shown in figure. The potential is minimum at the positive ion sites and maximum between the two ions.

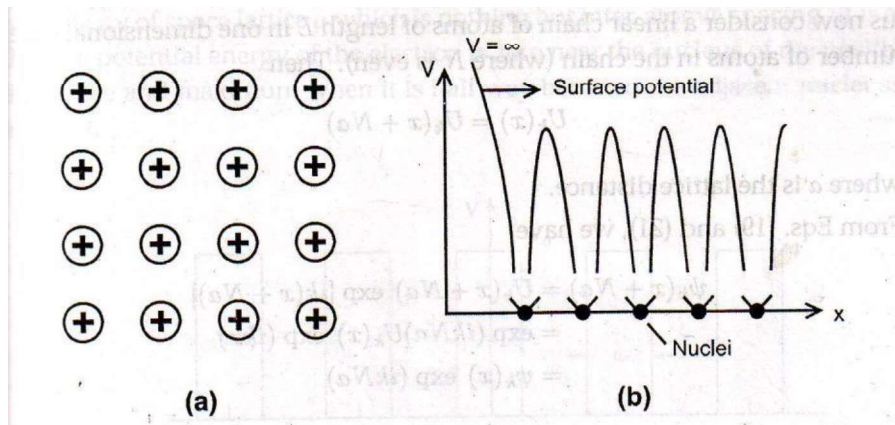

Periodic positive ion cores inside metallic crystals. b) One dimensional periodic potential in crystal.

The one dimension Schrodinger equation corresponding to this can be written as

$$\frac{d^2}{dx^2} + \frac{8\pi^2m[E-V(x)]}{h^2} \psi = 0 \quad \rightarrow (1)$$

The periodic potential $V(x)$ may be defined by means of the lattice constant „a“ as

$$V(x) = V(x+a) \quad \rightarrow (2)$$

Bloch considered the solution as

$$\psi_k(x) = \exp(ikx)U_k(x) \quad \rightarrow (3)$$

Eqn (2) is known as Bloch function. $U_k(x)$ is periodic with the periodicity of the crystal lattice. The free electron wave is modulated by periodic function $U_k(x)$ is periodic with the periodicity of the crystal lattice. The free electron wave is modulated by periodic function $U_k(x)$. For a linear chain of atoms of length „L“ in one dimensional case with „N“ (= even) number of atoms in the chain,

$$U_{\mathbf{k}}(\mathbf{x}) = U_{\mathbf{k}}(\mathbf{x} + N\mathbf{a}) \quad \rightarrow (4)$$

From eqn (3) and eqn (4)

$$\begin{aligned} \Psi_{\mathbf{k}}(\mathbf{x} + n\mathbf{a}) &= U_{\mathbf{k}}(\mathbf{x} + N\mathbf{a})^{[ik(x+)]} \\ &= (ikN) U_{\mathbf{k}}(\mathbf{x})^{(ik)} \\ &= \psi(\mathbf{e})^{(ikx)} \end{aligned} \quad \rightarrow (5)$$

This is referred to as Bloch condition.

Now,

$$\begin{aligned}\psi_{\kappa}(x+Na)\psi_{\kappa}^*(x+Na) &= \psi_{\kappa}(x)e^{(ikNa)}\psi_{\kappa}^*(x)e^{(-ikNa)} \\ &= \psi_{\kappa}(x)\psi_{\kappa}^*(x)e^{(0)} \\ \Psi_{\kappa}(x+Na)\Psi_{\kappa}^*(x+Na) &= \Psi_{\kappa}(x)\Psi_{\kappa}^*(x) \quad \rightarrow (6)\end{aligned}$$

This means that the electron is not located around any particular atom and the probability of finding the electron is same throughout the crystal.

The Kronig-Penny Model

The periodic potential assumed by Kronig and Penny is shown in Figure. i.e., a series of rectangular wells of width „a“ and are placed at a separation of b. in the regions where $0 < x < a$, the potential energy is zero and in regions such as $-b < x < 0$, the potential energy is V_0 .

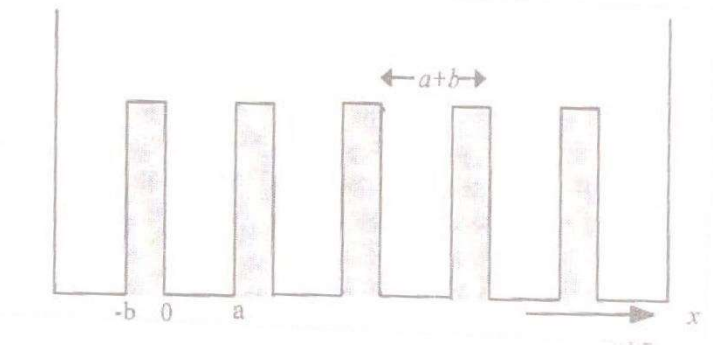

One dimensional periodic potential assumed by Kronig and Penny

The main features of the model and its predictions can be explained qualitatively

Main features of the model

A. Schrodinger equation:

The dynamical behavior of electrons in the Kronig-Penny model is represented by the following Schrodinger equation,

$$\begin{aligned}\frac{d^2\psi}{dx^2} + \frac{[2m]}{\hbar^2} E\psi &= 0 \quad \text{for } 0 < x < a \\ \text{And} \\ \frac{d^2\psi}{dx^2} + \frac{[2m]}{\hbar^2} (E - V_0)\psi &= 0 \quad \text{for } -b < x < 0 \quad \rightarrow (1)\end{aligned}$$

Let us assume that total energy „E“ of the electron under consideration is less than V_0 .

$$\text{Further, let us substitute } \alpha^2 = \frac{2mE}{\hbar^2} \quad \text{and} \quad \beta^2 = \frac{2m(V_0 - E)}{\hbar^2} \quad \rightarrow (2)$$

Where α and β are real quantities.

Now Eq(1) becomes

$$\begin{aligned}\frac{d^2\psi}{dx^2} + \alpha^2\psi &= 0, \quad \text{for } 0 < x < a \\ \text{And} \\ \frac{d^2\psi}{dx^2} - \beta^2\psi &= 0, \quad \text{for } -b < x < 0 \quad \rightarrow (3)\end{aligned}$$

These equations can be solved with the help of block theorem. The final solution of eq (3) is given in the form of the following condition.

$$\frac{P \sin \alpha a}{\alpha a} + \cos \alpha a = \cos ka \quad \rightarrow (4)$$

Where $P = \frac{mb^2 V_0 a}{2\hbar^2}$ is scattering power of the potential barrier and V_0 is barrier strength. That means, eq (3) will have a solution only when the condition (4) is satisfied.

Graph of αa versus $\frac{P \sin \alpha a}{\alpha a} + \cos \alpha a$

For the best understanding of the meaning of eq(4), let us consider the plot of the condition(4) i.e. L.H.S versus αa . Since the values of $\cos ka$ on R.H.s of eq (4) lie between +1 and -1, αa (which is a measure of energy) can take only those values for which the total left hand side (L.H.S) value lies between -1 and +1. Other values are not allowed. This means that energy E is restricted to lie within certain ranges which form the allowed energy bands or zones.

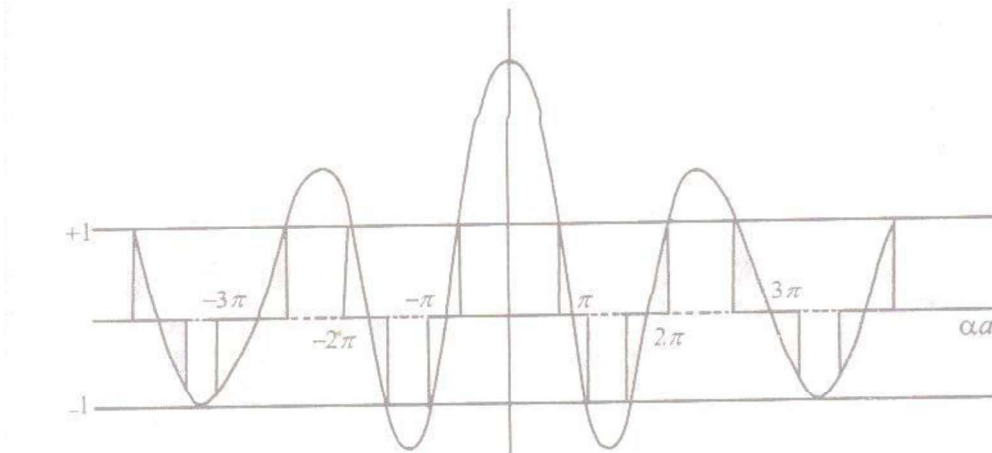

Plot of the left hand side of eq (4) as a function of αa for $p = \frac{3\pi}{2}$. The solid and broken lines on the abscissa (αa - axis) correspond to allowed and forbidden energy regions of the energy spectrum respectively that are plotted in fig.

Conclusions of the graph

1. The energy spectrum consists of alternative regions of allowed and vacant bands. Forbidden band implies that the energy levels that lie in this region are not occupied by the electrons.
2. The allowed (shaded) bands are narrowest for low values of energy and become broader as energy increases, the unallowed (forbidden) bands becoming narrower.
3. a) For $P=0$ (i.e. on the extreme left), the whole energy spectrum is quasi-continuous. That is all allowed bands are joined together forming an almost continuum.
b) However, the width of a particular allowed band decreases with increase in the value of P . As $P \rightarrow \infty$, the allowed energy bands compress into simple energy levels and thus result in a line spectrum.

Origin of Energy band formation in solids

In an isolated atom, the electrons are tightly bound and have discrete, sharp energy levels [Figure]. When two identical atoms are brought closer, the outermost orbits of these atoms overlap and interact.

When the wave functions of the electrons of the different atoms begin to overlap considerably, the energy levels split into two

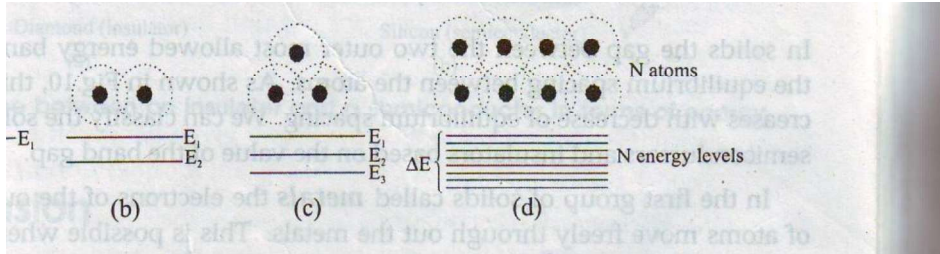

. Splitting of energy levels due to interatomic interaction

If more atoms are brought together, more levels are formed and for a solid of N atoms, each of the energy levels of an atom splits into N levels of energy [Figure].

The levels are so close together that they form an almost continuous band. The width of this band depends on the degree of overlap of the electrons of adjacent atoms and is largest for the outermost atomic electrons.

In a solid, many atoms are brought together that the split energy levels form a set of energy bands of very closely spaced levels with forbidden energy gaps between them. Overlapping of these atoms occurs for smaller equilibrium spacing r_0 .

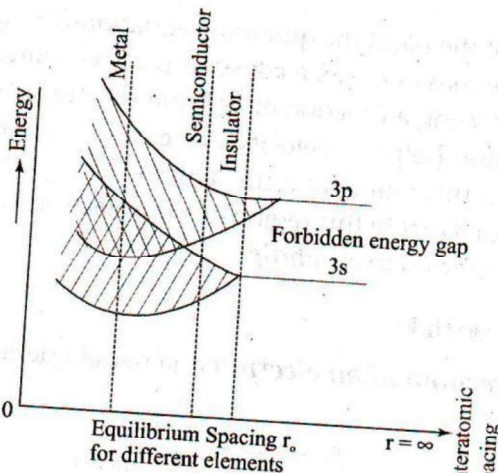

. With decrease of interatomic spacing overlapping of energy bands take place

The band corresponding to outermost orbit is called conduction band and the next band is called valence band. The gap between these two allowed bands is called forbidden energy gap or band gap. According to the width of the gap between the bands and band occupation by electrons all solids can be classified broadly into three groups namely, conductors, semiconductors and insulators

Classification of materials into conductors, semiconductors and insulators

On the basis of band theory, solids can be broadly classified into three categories, viz, insulators, semiconductors and conductors. Their band structures can be as shown in figure.

Insulators

1. In case of insulators, the forbidden gap is very wide. Due to this fact electrons cannot jump from valence band to conduction band.
2. They have completely filled valence band and completely empty conduction band.
3. The resistivity of insulators is very high.
4. Insulators are bad conductors of electricity.

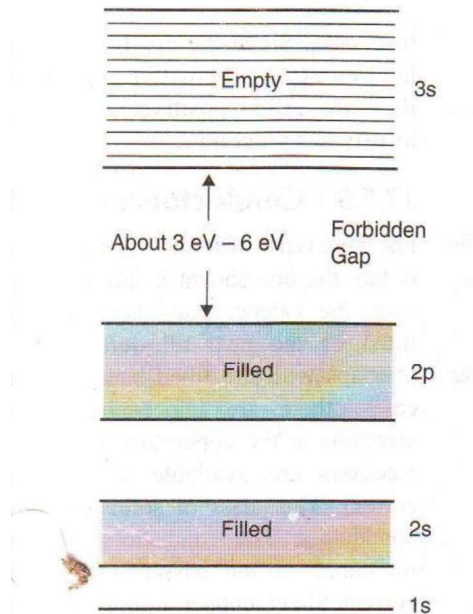

.Valence and conduction bands of insulator separated by large band gap

Semiconductors

1. In semiconductors, the band gap is very small (0.7 eV for germanium and 1.1 eV for silicon).
2. At 0k, there are no electrons in the conduction band and the valence band is completely filled. As the temperature increases, electrons from the valence band jump into conduction band.
3. The resistivity varies from 10^{-14} to $10^7 \Omega$ meter.

4. They have electrical properties between those of insulators and conductors.

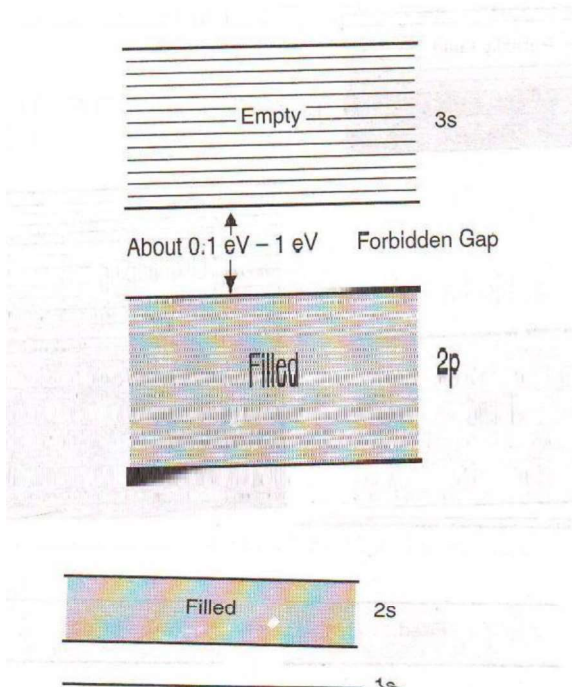

. Valence and conduction bands of semiconductor separated by small band gap

Conductors

1. In case of conductors, there is no forbidden gap and the valence band conduction band overlaps each other.
2. Plenty of free electrons are available for electrical conduction.
3. They possess very low resistivity and very high conductivity values.
4. Metals like copper, iron etc. are best examples of conductors.

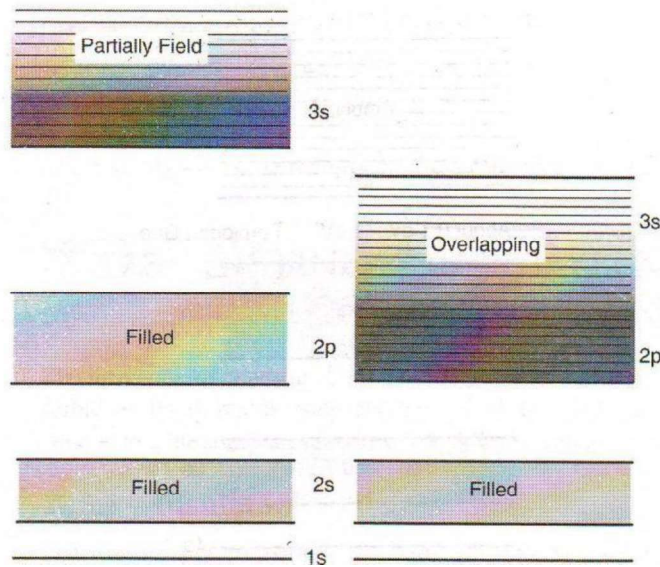

. Metals having (a) partially filled valence band and (b) overlap of completely filled valence band

Intrinsic Semiconductor

Pure germanium or silicon called an intrinsic semiconductor. Each atom possesses four valence electrons in outer most orbits. At $T = 0\text{K}$ a 2-D representation of the crystal of silicon & band diagram is shown in the figure .

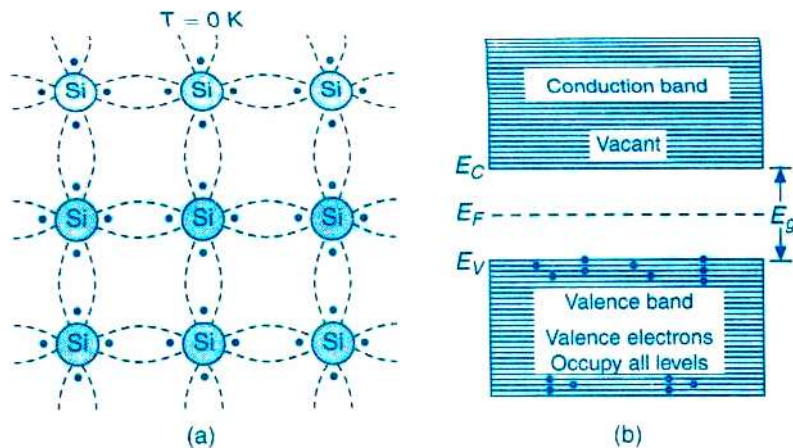

*Intrinsic silicon crystal at $T=0\text{K}$ (a) 2-D representation of silicon crystal
(c) Energy band diagram of intrinsic semiconductor*

Explanation: At 0K , all the valence electrons of silicon atoms are in covalent bonds and their energies constitute a band of energies called valance band (VB). So at 0K , VB is completely filled & conduction band (CB) is empty.

If we rise temperature ($T > 0\text{K}$), some of the electrons which are in covalent bonds break the bonds become free and move from VB to CB. The energy required should be greater than the energy gap of a semiconductor ($E > E_g$). The electron vacancy or deficiency created in VB is called holes. This is shown in the figure 3 below.

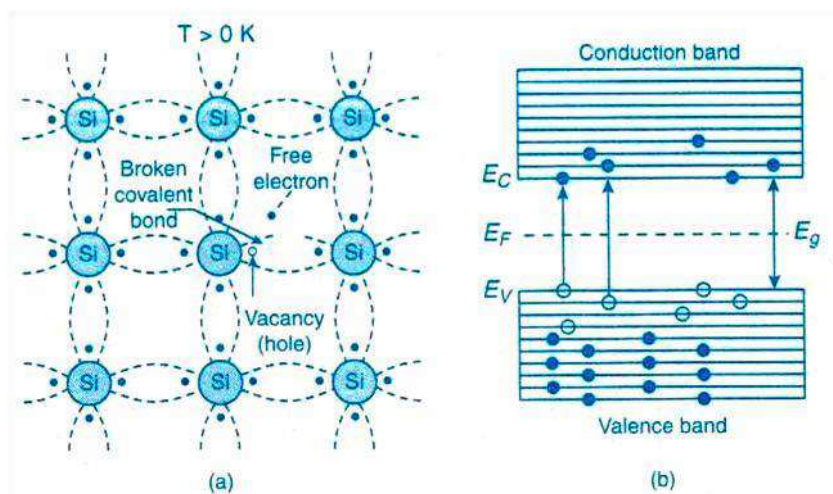

Silicon crystal at temperature above 0K (a) Due to thermal energy breaking of Covalent bonds take place (b) Energy band representation

Electron concentration in intrinsic semiconductor in conduction band (n)

Definition: The no. of free electrons per unit volume of the conduction band of a given intrinsic semiconductor is called electron concentration, represented by „n“.

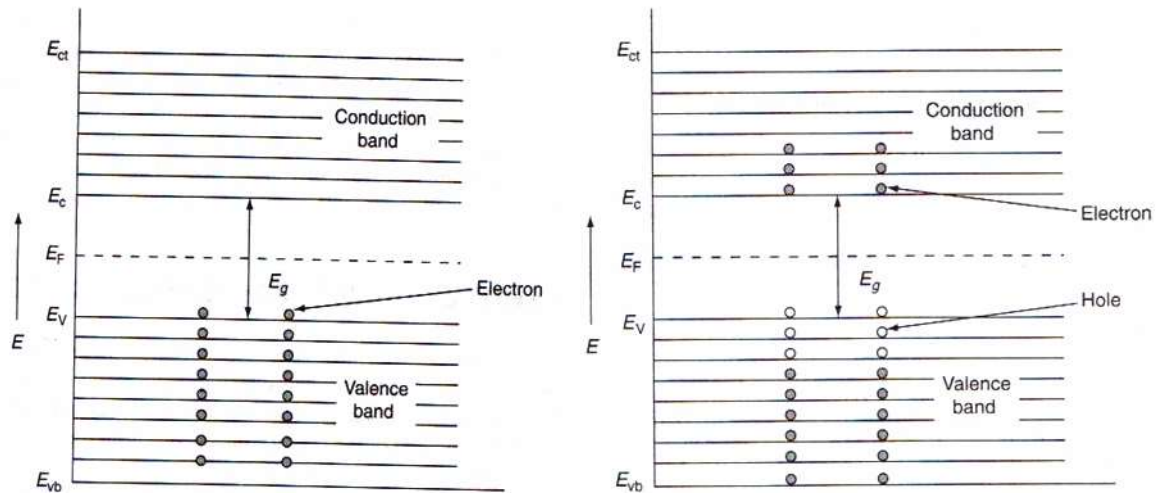

(a) Energy band diagram of silicon at $T = 0K$

(b) Energy band diagram of silicon at $T > 0K$

Derivation: Let the no. of free electrons per unit volume of the semiconductor having energies E and $E + dE$ in CB is represented by $n(E) dE$. It is obtained by multiplying the density of energy states $Z_C(E) d(E)$. [No. of energy states per unit volume] and Fermi – Dirac distribution function for the Probability of occupation of electrons $F_C(E)$

Therefore $n(E) dE = [Z_C(E) d(E)] [F_C(E)] \rightarrow (1)$

Where $Z_v(E) d(E) =$ Density of energy states

$F_h(E) =$ Probability of occupation of electrons given by Fermi – Dirac function

The total no. of electrons in CB per unit volume between the energies E_C to E_{ct} is given by integrating equation (1) with limits E_C to E_{ct}

$$n = \int_{E_C}^{E_{ct}} n(E) dE \rightarrow (2)$$

But equation (2) can be written as

$$n = \int_{E_C}^{\infty} n(E) dE + \int_{\infty}^{E_{ct}} n(E) dE \rightarrow (3)$$

$$n = \int_{E_C}^{\infty} n(E) dE - \int_{E_{ct}}^{\infty} n(E) dE \rightarrow (4)$$

In equation (4) the second term vanishes (disappears).

Since, above E_{ct} electrons do not present. Hence equation (4) becomes

$$n = \int_{E_C}^{\infty} n(E) dE$$

$$n = \int_{E_C}^{\infty} [Z_C(E) dE] \times F_C(E) \rightarrow (5)$$

{Since from equation (1)}

But $F_C(E)$ is Fermi – Dirac distribution function;

$$F_C(E) = \frac{1}{1 + e^{\frac{E-E_F}{k_B T}}} \rightarrow (6)$$

Here $E > E_F$, i.e. $e^{\frac{E-E_F}{k_B T}} \gg 1$

Hence „1“ can be neglected in equation (6)

$$F_C E = \frac{1}{e^{\frac{E-E_F}{k_B T}}}$$

$$F_C E = e^{\frac{E_F-E}{k_B T}} \rightarrow (7)$$

Also the density of electrons

$$Z_C(E) d(E) = \frac{\pi}{2} \left[\frac{8m^*}{\hbar^2} \right]^{\frac{3}{2}} (E - E_C)^{\frac{1}{2}} dE \rightarrow (8)$$

Here $E > E_C$. Since E_C is the minimum energy state in CB. Hence equation (8) becomes

$$Z_C(E) d(E) = \frac{\pi}{2} \left[\frac{8m^*}{\hbar^2} \right]^{\frac{3}{2}} (E - E_C)^{\frac{1}{2}} dE \rightarrow (9)$$

Substituting equations (7) & (9) in equation (5) we get

$$n = \int_{E_C}^{\infty} \frac{\pi}{2} \left[\frac{8m^*}{\hbar^2} \right]^{\frac{3}{2}} (E - E_C)^{\frac{1}{2}} e^{\frac{E_F-E}{k_B T}} dE$$

$$n = \frac{\pi}{2} \left[\frac{8m^*}{\hbar^2} \right]^{\frac{3}{2}} \int_{E_C}^{\infty} (E - E_C)^{\frac{1}{2}} e^{\frac{E_F-E}{k_B T}} dE \rightarrow (10)$$

Let $\epsilon = E - E_C$

$d\epsilon = dE$ { is constant } . The limits are $\epsilon = 0$ to $\epsilon = \infty$

Hence equation (10) can be written as

$$n = \frac{\pi}{2} \left[\frac{8m^*}{\hbar^2} \right]^{\frac{3}{2}} \int_{\epsilon=0}^{\infty} (\epsilon)^{\frac{1}{2}} e^{\frac{E_F - \epsilon + E_C}{k_B T}} d\epsilon$$

$$n = \frac{\pi}{2} \left[\frac{8m^*}{\hbar^2} \right]^{\frac{3}{2}} e^{\frac{(E_F - E_C)}{k_B T}} \int_{\epsilon=0}^{\infty} (\epsilon)^{\frac{1}{2}} e^{\frac{-\epsilon}{k_B T}} d\epsilon \rightarrow (11)$$

In equation (11) But $\int_{\epsilon=0}^{\infty} (\epsilon)^{\frac{1}{2}} e^{\frac{-\epsilon}{k_B T}} d\epsilon = \frac{1}{2} (k_B T)^{\frac{3}{2}}$ $\rightarrow (12)$

Substituting (12) in (11) we get

$$n = \frac{\pi}{2} \left[\frac{8m^*}{\hbar^2} \right]^{\frac{3}{2}} e^{\frac{(E_F - E_C)}{k_B T}} \frac{\pi}{2} (k_B T)^{\frac{3}{2}}$$

$$n = \frac{1}{4} \left[\frac{8\pi m^* k_B T}{\hbar^2} \right]^{\frac{3}{2}} e^{\frac{(E_F - E_C)}{k_B T}}$$

$$n = \frac{1}{4} \left[\frac{8\pi m^* k_B T}{\hbar^2} \right]^{\frac{3}{2}} e^{\frac{(E_F - E_C)}{k_B T}}$$

$$n = 2 \left[\frac{2\pi m^* k_B T}{\hbar^2} \right]^{\frac{3}{2}} e^{\frac{-(E_C - E_F)}{k_B T}} \rightarrow (13)$$

{Here $N_C = 2 \left[\frac{2\pi m^* k_B T}{\hbar^2} \right]^{\frac{3}{2}}$ } Therefore $n = N_C e^{\frac{-(E_C - E_F)}{k_B T}}$

Hole concentration in the valance band of intrinsic semiconductor(p)

Definition: The number of holes per unit volume of the valance band of a given intrinsic semiconductor is called hole concentration, represented by „p“.

Derivation: Let the number of holes per unit volume of the semiconductor having energies $E, E + dE$ in VB is represented by $p(E) dE$. It is obtained by multiplying the density of energy states $Z_V(E) d(E)$ [No. of energy states per unit volume] and Fermi – Dirac distribution function for the Probability of occupation of holes $F_h(E)$.

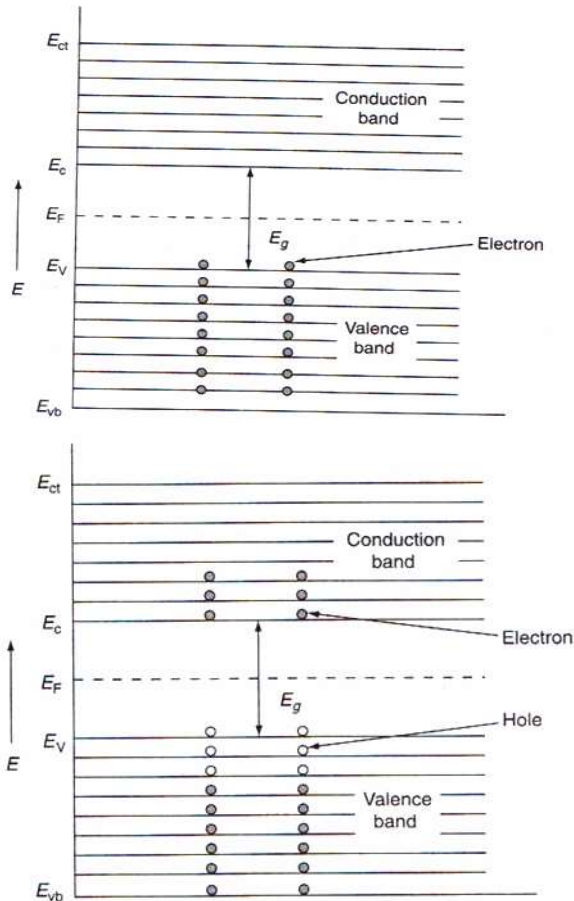

(a) Energy band diagram of silicon at $T = 0K$
 (b) Energy band diagram of silicon at $T > 0K$

Therefore $\int p(E) dE = [Z_v(E) d(E)] [F_h(E)] \rightarrow (1)$

Where $Z_v(E) d(E) =$ Density of energy states.

$F_h(E) =$ Hole probability given by Fermi – Dirac function

The total no. of holes in VB per unit volume between the energies E_{vb} to E_v is given by integrating equation (1) with limits E_{vb} to E_v

$$p = \int_{E_{vb}}^{E_v} p(E) dE \rightarrow (2)$$

But equation (2) can be written as

$$p = \int_{-\infty}^{E_v} p(E) dE + \int_{E_v}^{E_{vb}} p(E) dE \rightarrow (3)$$

$$p = - \int_{-\infty}^{E_{vb}} p(E) dE + \int_{-\infty}^{E_v} p(E) dE \rightarrow (4)$$

In equation (4) the first term vanishes (disappears).

Since, below E_{vb} holes do not present. Hence equation (4) becomes

$$p = \int_{-\infty}^{E_v} p(E) dE$$

$$p = \int_{-\infty}^{E_v} Z_v(E) dE \times F_h(E) \rightarrow (5)$$

{Since from equation (1)}

But $F_h(E)$ is Fermi – Dirac distribution function;

$$F_{\square} E = 1 - \frac{1}{1 + e^{\frac{E-E_F}{k_B T}}} \rightarrow (6)$$

Simplifying;

$$F E = \frac{e^{\frac{E-E_F}{k_B T}}}{1 + e^{\frac{E-E_F}{k_B T}}}$$

□

Divide by $e^{\frac{E-E_F}{k_B T}}$ we get

$$F_{\square} E = \frac{1}{1 + \frac{1}{e^{\frac{E-E_F}{k_B T}}}}$$

$$F_{\square} E = \frac{1}{1 + e^{\frac{E_F-E}{k_B T}}} \rightarrow (6)$$

Here $E_F > E$, i. e. $e^{\frac{E_F-E}{k_B T}} \gg 1$

Hence „1“ can be neglected in equation (6)

$$F_{\square} E = \frac{1}{e^{\frac{E_F-E}{k_B T}}}$$

$$F = k_B T \rightarrow (7)$$

Also the density of holes

$$Z_v(E) d(E) = \frac{\pi}{2} \left[\frac{8m^*}{\hbar^2} \right]^{\frac{3}{2}} (E_v - E)^{\frac{1}{2}} dE \rightarrow (8)$$

Here $E < E_v$. Since E_v is the maximum energy state in VB. Hence equation (8) becomes

$$Z_v(E) d(E) = \frac{\pi}{2} \left[\frac{8m^*}{\hbar^2} \right]^{\frac{3}{2}} (E_v - E)^{\frac{1}{2}} dE \rightarrow (9)$$

Substituting equations (7) & (9) in equation (5) we get

$$p = \int_{-\infty}^{E_v} \frac{\pi}{2} \left[\frac{8m^*}{\hbar^2} \right]^{\frac{3}{2}} (E_v - E)^{\frac{1}{2}} e^{\frac{E-E_F}{k_B T}} dE$$

$$p = \frac{\pi}{2} \left[\frac{8m^*}{\hbar^2} \right]^{\frac{3}{2}} \int_{-\infty}^{E_v} (E_v - E)^{\frac{1}{2}} e^{\frac{E-E_F}{k_B T}} dE \rightarrow (10)$$

Let $\varepsilon = E_v - E$

$d\varepsilon = -dE$ { E_v is constant } . The limits are $\varepsilon = \infty$ to $\varepsilon = 0$

Hence equation (10) can be written as

$$p = \frac{\pi}{2} \left[\frac{8m^*}{\hbar^2} \right]^{\frac{3}{2}} \int_{\varepsilon=\infty}^0 (\varepsilon)^{\frac{1}{2}} e^{\frac{(E_v-\varepsilon)-E_F}{k_B T}} d\varepsilon$$

$$p = \frac{\pi}{2} \left[\frac{8m^*}{\hbar^2} \right]^{\frac{3}{2}} e^{\frac{(E_v-E_F)}{k_B T}} \int_{\varepsilon=0}^{\infty} (\varepsilon)^{\frac{1}{2}} e^{-\frac{\varepsilon}{k_B T}} d\varepsilon \rightarrow (11)$$

In equation (11) But $\int_{\varepsilon=0}^{\infty} (\varepsilon)^{\frac{1}{2}} e^{-\frac{\varepsilon}{k_B T}} d\varepsilon = \frac{\pi}{2} (k_B T)^{\frac{3}{2}} \rightarrow (12)$

Substituting (12) in (11) we get

$$p = \frac{\pi}{2} \left[\frac{8m^*}{\hbar^2} \right]^{\frac{3}{2}} e^{\frac{(E_v-E_F)}{k_B T}} \frac{\pi}{2} (k_B T)^{\frac{3}{2}}$$

$$p = \frac{1}{4} \left[\frac{8\pi m^* k_B T}{\hbar^2} \right]^{\frac{3}{2}} e^{\frac{(E_v-E_F)}{k_B T}}$$

$$p = \frac{1}{4} \left[\frac{8\pi m^* k_B T}{\hbar^2} \right]^{\frac{3}{2}} e^{\frac{(E_v-E_F)}{k_B T}}$$

$$p = 2 \left[\frac{2\pi m_p^* K T}{h^2} \right]^{3/2} e^{-\frac{(E_F - E_V)}{K_B T}} \rightarrow (13)$$

{Here $N_V = 2 \left[\frac{2\pi m_p^* K T}{h^2} \right]^{3/2}$ }

$$p = N_V e^{-\frac{(E_F - E_V)}{K_B T}}$$

Fermi energy level in intrinsic semiconductor

At temperature T K, the electron concentration „ n “ is equal to hole concentration „ p “ in intrinsic semiconductor.

$$n = p$$

$$2 \left[\frac{2\pi m_n^* K T}{h^2} \right]^{3/2} e^{-\frac{E_C - E_F}{K_B T}} = 2 \left[\frac{2\pi m_p^* K T}{h^2} \right]^{3/2} e^{-\frac{(E_F - E_V)}{K_B T}}$$

On simplifying we get

$$\left(\frac{m_n^*}{m_p^*} \right)^{3/2} e^{-\frac{(E_C - E_F)}{K_B T}} = \left(\frac{m_p^*}{m_n^*} \right)^{3/2} e^{-\frac{(E_F - E_V)}{K_B T}}$$

$$\frac{e^{-\frac{E_C - E_F}{K_B T}}}{e^{-\frac{E_F - E_V}{K_B T}}} = \left(\frac{m_p^*}{m_n^*} \right)^3$$

$$e^{\frac{E_C + E_F + E_F - E_V}{K_B T}} = \left[\frac{m_p^*}{m_n^*} \right]^3$$

$$e^{\frac{2E_F - (E_C - E_V)}{K_B T}} = \left[\frac{m_p^*}{m_n^*} \right]^3$$

Taking logarithms on both sides we get

$$\frac{2E_F - (E_C - E_V)}{K_B T} = \frac{3}{2} \ln \left[\frac{m_p^*}{m_n^*} \right]$$

$$\frac{2E_F}{K_B T} = \frac{(E_C - E_V)}{K_B T} + \frac{3}{2} \ln \left[\frac{m_p^*}{m_n^*} \right]$$

$$E_F = \frac{(E_C - E_V)}{2} + \frac{3}{4} K_B T \ln \left[\frac{m_p^*}{m_n^*} \right] \quad \{ \text{At } T > 0K \}$$

Let $T = 0K$

$$E_F = \frac{(E_C + E_V)}{2}$$

This means E_F lies in the middle between (E_C & E_V) of the energy gap „ E_g “

As the temperature increases the electrons move from VB to CB. Also the Fermi level slightly rises upwards towards CB. Hence $E_F = \frac{(E_C + E_V)}{2} + \frac{3}{4} K_B T \ln \left[\frac{m_p^*}{m_n^*} \right]$. It is shown in the figure 6 below.

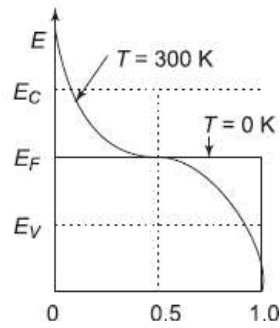
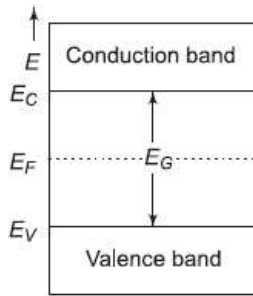

(a) Fermi level E_F at $T = 0K$ (b) Upward shift of E_F near E_C at $T > 0k$

Intrinsic carrier concentration (n_i)

Definition: The no. of free electrons and holes per unit volume of the intrinsic semiconductor is called intrinsic carrier concentration (n_i) remains constant.

i.e.

$$n = p = n_i$$

$$n p = (n_i) (n_i)$$

$$n_i^2 = (n p) \rightarrow (1)$$

$$n_i = (np)^{\frac{1}{2}} \rightarrow (2)$$

Consider equation (1)

$$n_i^2 = (n p)$$

$$n_i^2 = 2 \left[\frac{2\pi m_e^* K}{2\pi K_B T} \right]^{\frac{3}{2}} T^{\frac{3}{2}} e^{-\frac{E_C - E_F}{K_B T}} \times 2 \left[\frac{2\pi m_p^* K}{2\pi K_B T} \right]^{\frac{3}{2}} T^{\frac{3}{2}} e^{-\frac{E_F - E_V}{K_B T}}$$

$$= 4 \left[\frac{2\pi m_e^* K}{2\pi K_B T} \right]^{\frac{3}{2}} \left[\frac{2\pi m_p^* K}{2\pi K_B T} \right]^{\frac{3}{2}} T^3 e^{-\frac{E_C + E_F - E_F + E_V}{K_B T}}$$

$$n_i^2 = 4 \frac{(2\pi m_e^* K)^{\frac{3}{2}} (2\pi m_p^* K)^{\frac{3}{2}}}{(2\pi K_B T)^3} e^{K_B T} \left\{ \text{Since } E_C - E_V = E_g \right\}$$

$$n_i = 2 \frac{(2\pi m_e^* K)^{\frac{3}{2}} (2\pi m_p^* K)^{\frac{3}{2}}}{(2\pi K_B T)^3} e^{-\frac{E_g}{K_B T}}$$

If $m_e^* = m_p^* = m^*$, the above equation becomes

$$n_i = 2 \frac{(2\pi m^* K)^3}{(2\pi K_B T)^3} e^{-\frac{E_g}{K_B T}}$$

$$n_i = 2 \frac{(2\pi m^* K)^3}{(2\pi K_B T)^3} e^{-\frac{E_g}{K_B T}}$$

Let $\frac{2 (2\pi m^* K)^3}{(2\pi K_B T)^3} T^{\frac{3}{2}} = C$.

Then

$$n_i = C T^{\frac{3}{2}} e^{-\frac{E_g}{K_B T}}$$

Extrinsic (or) Impure semiconductor

Introduction: The conductivity of an intrinsic semiconductor can be increased by adding small amounts of impurity atoms, such as IIIrd or Vth group atoms. The conductivity of silica is increased by 1000 times on adding 10 parts of boron per million part of silicon. The process of adding impurities is called doping and the impurity added is called dopant.

N – Type semiconductor

In a pure (intrinsic) semiconductor, when pentavalent an impurity like Phosphorous atom consisting of five valence electrons is doped, and then concentration of electrons increases than holes. Hence the given semiconductor formed is called N – type semiconductor. This is shown in the figure 7a below. By adding donor impurities, the free electrons generated or donated, form an energy level called as “Donor energy level” i.e. E_D is shown in the figure below.

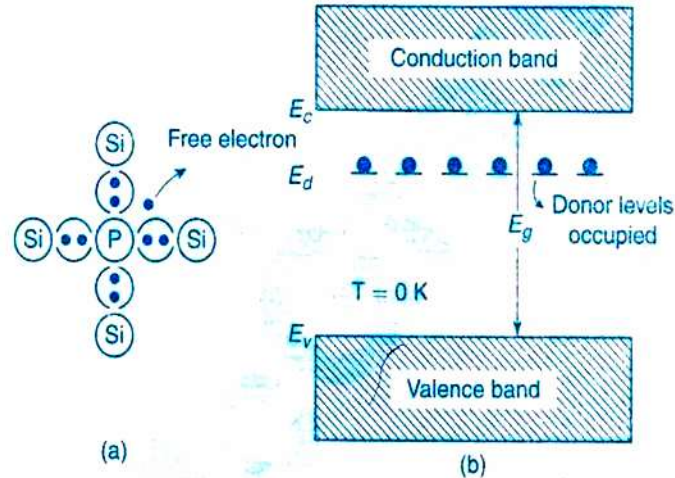

(a) Representation of n- type silicon at $T = 0K$ (b) Energy band diagram at $T = 0K$

In the figure (b) E_F is Fermi energy level is in between E_C & E_D at $T = 0K$.

Hence $E_F = \frac{E_C + E_D}{2}$. The donor level, E_D “ is near to E_F consisting of free electrons. But CB is empty.

Variation of Fermi level E_F with respect to temperature in N -type

As temperature increases the electrons in the Donor level ' E_D ' moves into CB leaving holes. Also The Fermi level slightly shifts upwards towards CB. If further increase of temperature is done, the hole concentration also increases with respect to electron concentration. Hence it reaches again the concentration of $n = p$ i.e. an intrinsic semiconductor. At last the Fermi level drops in the middle of the energy gap (or) Forbidden band gap, indicating a pure semiconductor that is towards ' E_i '. This happens only for very high temperatures as shown in the figure 8 below.

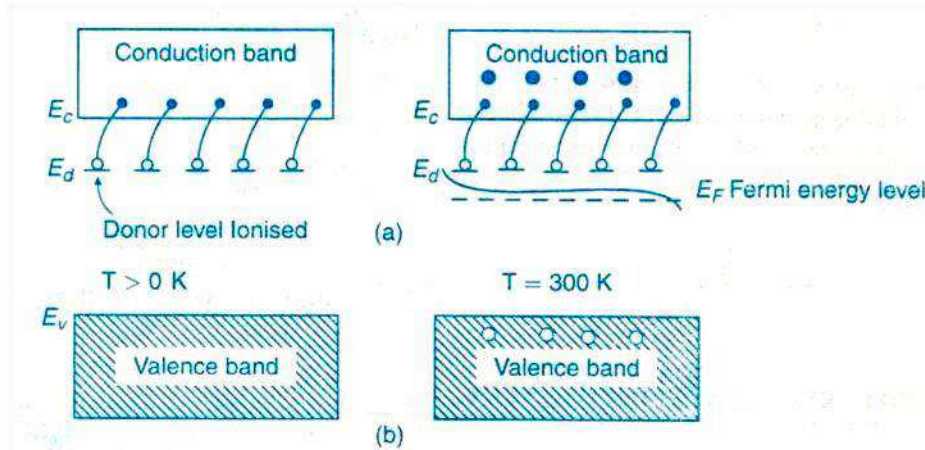
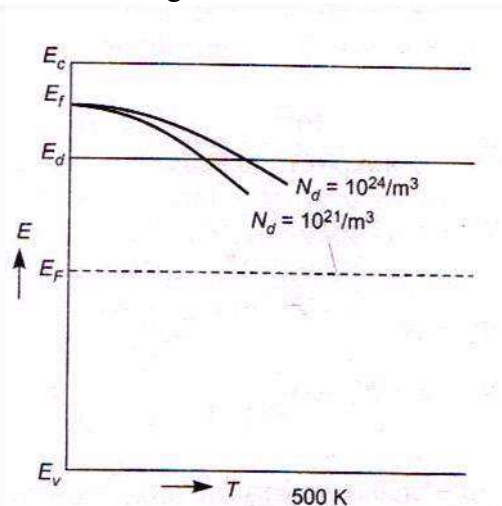

Fig. Variation of Fermi level wrt temperature in n- type semiconductor

Variation of E_F with respect to donor concentration

As the donor concentration increases the Fermi level decreases (lowers) as in case of intrinsic semiconductor „ E_i . This is shown in the figure below



Variation of Fermi level with temperature for different donor concentrations in an n-type semiconductor

Carrier concentration in N – type semiconductor & Density of electrons in CB

Let N_D is the donor concentration (no. of donor atoms per unit volume). Let it be written as

Or written as

$$= N_D \exp \left[\frac{-E_F - E_D}{K_B T} \right]$$

$$= N_D e^{\frac{-(E_F - E_D)}{K_B T}} \rightarrow (1)$$

The density of electrons in CB in pure semiconductor is given by

$$= 2 \left[\frac{2\pi m^* K T}{h^2} \right]^{3/2} e^{\frac{-(E_C - E_F)}{K_B T}} \rightarrow (2)$$

At very low temperatures the no. of electrons in CB must be equal to the no. of donor atoms per unit volume. Hence equating equations (1) & (2) we get

$$2 \left[\frac{2\pi m^* K T}{\hbar^2} \right]^2 e^{-\frac{(E_C - E_F)}{K_B T}} = N_D e^{-\frac{(E_F - E_D)}{K_B T}}$$

$$\frac{e^{-\frac{(E_C + E_F)}{K_B T}}}{e^{-\frac{(E_F + E_D)}{K_B T}}} = \frac{N_D}{2 \left[\frac{2\pi m^* K T}{\hbar^2} \right]^2}$$

$$e^{\frac{-E_C + E_F + E_F - E_D}{K_B T}} = \frac{N_D}{2 \left[\frac{2\pi m^* K T}{\hbar^2} \right]^2}$$

$$e^{\frac{2E_F - (E_C + E_D)}{K_B T}} = \frac{N_D}{2 \left[\frac{2\pi m^* K T}{\hbar^2} \right]^2}$$

Taking logarithms on both sides we get

$$\frac{2E_F - (E_C + E_D)}{K_B T} = \log \left[\frac{N_D}{2 \left[\frac{2\pi m^* K T}{\hbar^2} \right]^2} \right]$$

$$2E_F - (E_C + E_D) = K_B T \log \left[\frac{N_D}{2 \left[\frac{2\pi m^* K T}{\hbar^2} \right]^2} \right]$$

$$E_F = \frac{(E_C + E_D)}{2} + \frac{K_B T}{2} \log \left[\frac{N_D}{2 \left[\frac{2\pi m^* K T}{\hbar^2} \right]^2} \right] \quad \{ \text{At } T > 0K \} \rightarrow (3)$$

Case I: At T=0K

$$E_F = \frac{(E_C + E_D)}{2}. \text{ That is } E_F \text{ lies between } E_C \text{ \& } E_D$$

Case II: At T>0K. As temperature increases the Fermi level slightly shifts upwards towards CB, hence

$$E_F = \frac{(E_C + E_D)}{2} + \frac{K_B T}{2} \log \left[\frac{N_D}{2 \left[\frac{2\pi m^* K T}{\hbar^2} \right]^2} \right]$$

Density of electrons in CB in extrinsic semiconductor:

Here consider equation (2). That is

$$= 2 \left[\frac{2\pi m^* K T}{\hbar^2} \right]^2 e^{-\frac{(E_C - E_F)}{K_B T}}$$

OR

$$= 2 \left[\frac{2\pi m^* K T}{\hbar^2} \right]^2 e^{\frac{(E_F - E_C)}{K_B T}}$$

Substitute the value of E_F from equation (3) in equation (2), it becomes (Extrinsic N-)

$$(Extrinsic N-type) = 2 \left[\frac{2\pi m^* K T}{\hbar^2} \right]^2 \exp \left\{ \frac{(E_C + E_D)}{2} \frac{K_B T}{K_B T} + \log \frac{N_D}{2 \left[\frac{2\pi m^* K T}{\hbar^2} \right]^2} - E_C \right\}$$

On simplifying

We know that $\exp(a + b) = \exp(a) \times \exp(b)$

Also $\exp(\log x) = x$

$$= 2 \left[\frac{2\pi m^* K_B T}{\hbar^2} \right]^2 \exp \left(\frac{E_D - E_C}{2K_B T} \right) \left\{ \frac{1}{2} \frac{(N_D)^2}{\left[\frac{2\pi m^* K T}{\hbar^2} \right]^4} \right\}$$

$$(Extrinsic N-type) = (2N_D)^2 \left[\frac{2\pi m^* K T}{\hbar^2} \right]^3 \exp \left(\frac{-(E_C - E_D)}{2K_B T} \right)$$

OR

$$n_{(Extrinsic N-type)} = (2N_D)^2 \left[\frac{2\pi m^* K_B T}{\hbar^2} \right]^3 e^{-\frac{(E_C - E_D)}{2K_B T}}$$

P- type semiconductor

P – Type semiconductor is formed by doping with trivalent impurity atoms (acceptor) like IIIrd group atoms i.e. Aluminum, Gallium, and Indium etc to a pure semiconductor like Ge or Si. As the acceptor trivalent atoms has only three valence electrons & Germanium, Silicon has four valence electrons; holes or vacancy is created for each acceptor dopant atom. Hence holes are majority and electrons are minority. It is shown in the figure a below. Also an acceptor energy level „ E_A “ is formed near VB consisting of holes, as shown in the figure below.

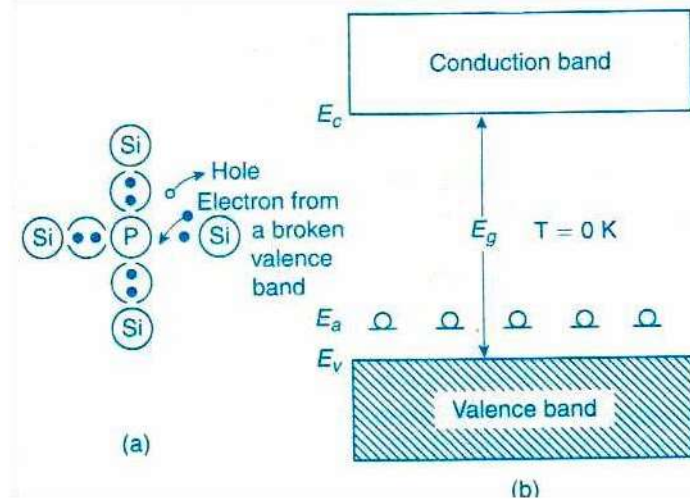

(a) Representation of p- type silicon at $T = 0\text{ K}$ (b) Energy band diagram at $T = 0\text{ K}$

As temperature increases ($T > 0\text{ K}$) the electrons in VB which are in covalent bonds break the bonds become free and move from VB to acceptor energy level E_A .

Variation of Fermi level E_F with respect to temperature in P- type semiconductor

As temperature increases the Fermi level E_F slightly drops towards VB. For further increase of high temperatures the electron concentration also increases with respect to hole concentration. Hence a condition is reached such that „ $n = p$ “ i.e. it becomes an intrinsic or pure semiconductor. Hence the Fermi level increases and reaches to intrinsic level E_i as in case of pure semiconductor. This is shown in the figure below

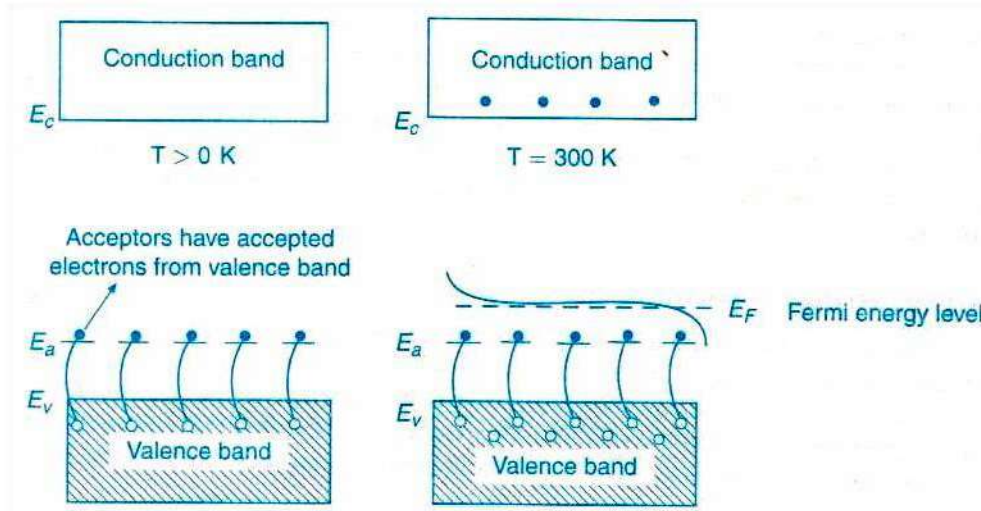

Variation of Fermi level wrt temperature in p-type

Variation of Fermi level with respect to acceptor concentration:

Also as the acceptor concentration increases we find that Fermi level E_F reaches (increases) towards intrinsic level E_i as in case of pure or intrinsic semiconductor. This is shown in the figure below.

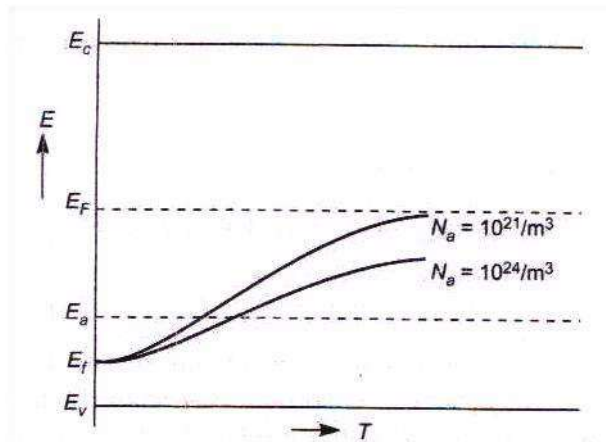

Variation of Fermi level with temperature for different acceptor concentrations in a p-type

Carrier concentration of P- type semiconductor & Density of holes in VB

Let N_A is the acceptor concentration (no. of acceptor atoms per unit volume). Let it be written as

$$= N_A \exp \left[-\frac{E_A - E_F}{k_B T} \right]$$

Or written as

$$= N_A e^{\frac{(E_F - E_A)}{k_B T}} \rightarrow (1)$$

The density of holes in VB in pure semiconductor is given by

$$= 2 \left[\frac{2\pi m^* k_B T}{h^2} \right]^{3/2} e^{\frac{-(E_F - E_V)}{k_B T}} \rightarrow (2)$$

At very low temperatures the no. of holes in VB must be equal to the no. of acceptor atoms per unit volume. Hence equating equations (1) & (2) we get

$$2 \left[\frac{2\pi m^* K T}{\hbar^2} \right]^{3/2} e^{\frac{-(E_F + E_V)}{K_B T}} = N_A \frac{e^{\frac{(E_F - E_A)}{K_B T}}}{2 \left[\frac{2\pi m^* K T}{\hbar^2} \right]^{3/2}}$$

$$\frac{e^{\frac{-(E_F + E_V)}{K_B T}}}{e^{\frac{(E_F - E_A)}{K_B T}}} = \frac{N_A}{2 \left[\frac{2\pi m^* K T}{\hbar^2} \right]^{3/2}}$$

$$e^{\frac{-E_F + E_V - E_F + E_A}{K_B T}} = \frac{N_A}{2 \left[\frac{2\pi m^* K T}{\hbar^2} \right]^{3/2}}$$

$$e^{\frac{-2E_F + (E_V + E_A)}{K_B T}} = \frac{N_A}{2 \left[\frac{2\pi m^* K T}{\hbar^2} \right]^{3/2}}$$

Taking logarithms on both sides we get

$$\frac{-2E_F + (E_V + E_A)}{K_B T} = \log \left[\frac{N_A}{2 \left[\frac{2\pi m^* K T}{\hbar^2} \right]^{3/2}} \right]$$

$$-2E_F + (E_V + E_A) = K_B T \log \left[\frac{N_A}{2 \left[\frac{2\pi m^* K T}{\hbar^2} \right]^{3/2}} \right]$$

$$E_F = \frac{(E_V + E_A)}{2} - \frac{K_B T}{2} \log \left[\frac{N_A}{2 \left[\frac{2\pi m^* K T}{\hbar^2} \right]^{3/2}} \right] \quad \{\text{At } T > 0K\} \rightarrow (3)$$

Case I: At T=0K

$$E_F = \frac{(E_V + E_A)}{2}. \text{ That is } E_F \text{ lies between } E_V \text{ \& } E_A$$

Case II: At T>0K. As temperature increases the Fermi level slightly drops towards VB, hence

$$E_F = \frac{(E_V + E_A)}{2} - \frac{K_B T}{2} \log \left[\frac{N_A}{2 \left[\frac{2\pi m^* K T}{\hbar^2} \right]^{3/2}} \right]$$

Density of electrons in CB in extrinsic semiconductor

Here consider equation (2). That is

$$= 2 \left[\frac{2\pi m^* K T}{\hbar^2} \right]^{3/2} e^{\frac{-(E_F - E_V)}{K_B T}}$$

OR

$$= 2 \left[\frac{2\pi m^* K T}{\hbar^2} \right]^{3/2} e^{\frac{-(E_F + E_V)}{K_B T}}$$

Substitute the value of E_F from equation (3) in equation (2), it becomes (Extrinsic P-)

$$(\text{Extrinsic P-type}) = 2 \left[\frac{2\pi m^* K T}{\hbar^2} \right]^{3/2} \exp \left[\frac{\frac{-(E_V + E_A) K_B T}{2} + \frac{K_B T}{2} \log \left[\frac{N_A}{2 \left[\frac{2\pi m^* K T}{\hbar^2} \right]^{3/2}} \right] + E_V}{K_B T} \right]$$

On simplifying

We know that $\exp(a + b) = \exp(a) \times \exp(b)$

Also $\exp(\log x) = x$

$$= 2 \left[\frac{2\pi m^* K T}{\hbar^2} \right]^{3/2} \exp \left[\frac{(E_V - E_A)}{2 K_B T} \right] \left\{ \frac{N_A}{2 \left[\frac{2\pi m^* K T}{\hbar^2} \right]^{3/2}} \right\}$$

$$(\text{Extrinsic P-type}) = (2 N_A)^2 \left[\frac{2\pi m^* K T}{\hbar^2} \right]^{3/4} \exp \left[\frac{-(E_A - E_V)}{2 K_B T} \right]$$

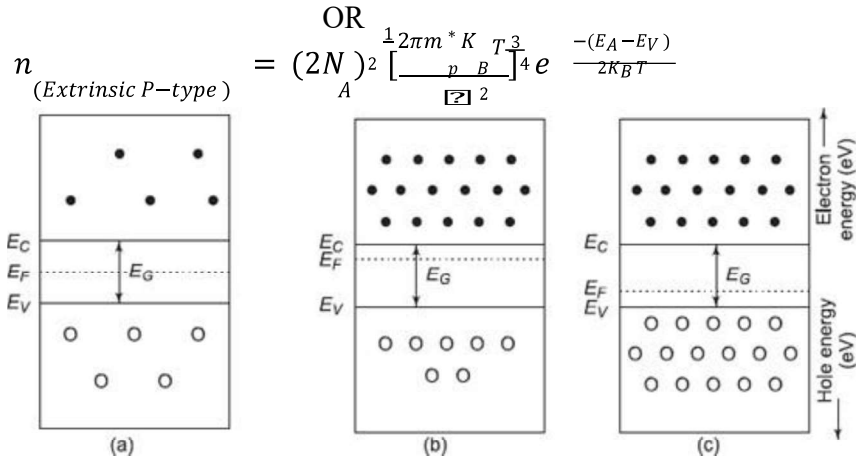

Energy band diagrams of (a) Intrinsic semiconductor (b) N- type & (c) P- type semiconductors

Hall Effect

Determination of Hall coefficient R_H , Hall voltage V_H & Applications of Hall Effect

Definition:

If a piece of semiconductor carrying a current „I“ is placed in a transverse or perpendicular magnetic field, then an Electric field „ E_H “ is generated in perpendicular to both „I“ and „B“. Hence production of Hall electric field „ E_H “ and generation of Hall voltage V_H by applying current „I“ & „B“ in perpendicular directions is called Hall Effect.

Derivation of R_H , V_H , & E_H :

Assume an N – type semiconductor. Let „I“ be the current passed along X- axis. Let „B“ the magnetic field applied along „Z“ axis. Due to current „I“, due to the flow of electrons, the force acting on electrons is in opposite direction to the direction of conventional current.

Due to the magnetic field „B“ there is a down ward force act on each electron given by Bev . This makes the electrons deviated in a down ward direction along Z – axis. This causes a negative charge to accumulate on the bottom face.

Hence $F_B = Bev$

Where „e“ = charge of electron, v = velocity of electron

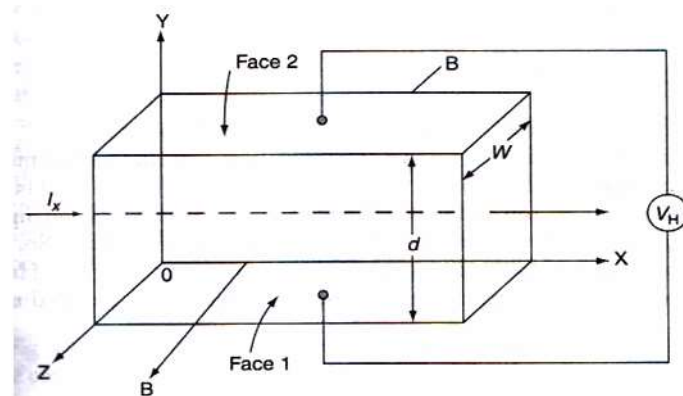

A semiconductor applied to current and magnetic field perpendicularly in Hall Effect

A potential difference is formed from top to bottom of the specimen. The potential difference causes a field E_H to flow along negative Y- axis. Due to E_H along negative Y- direction a force of eE_H acts in upward direction along positive Y- axis.

Hence $F_E = e E_H$

Under equilibrium condition

Upward force due to E_H = Downward force due to B.

$$F_B = F_E$$

$$e E_H = Bev$$

$$v = \frac{E_H}{B} \rightarrow (1)$$

If J is the current density then $J = nev$

$$v = \frac{J}{ne} \rightarrow (2)$$

Equating (1) & (2) we get

$$\frac{E_H}{B} = \frac{J}{ne}$$

$$E_H = \frac{JB}{ne}$$

$$E_H = \left[\frac{-1}{ne} \right] B J$$

Let Hall coefficient

$$R_H = \frac{-1}{ne} \quad \text{for electrons}$$

$$R_H = \frac{-1}{pe} \quad \text{for holes}$$

$$\text{Hence} \quad E_H = R_H B J \rightarrow (4)$$

$$R_H = \frac{-1}{ne} \rightarrow (5)$$

Where n= electron density, P = hole density, E_H = Hall electric field, R_H = Hall coefficient
B = magnetic field, J = current density

Experimental determination of R_H

Consider equation (5)

$$R_H = \frac{-E_H}{B J}$$

Let V_H is the Hall voltage across the sample of thickness,,t“

Generally

$$V = Ed$$

In Hall effect

$$V_H = E_H \times t$$

$$\frac{E_H}{t} = \rightarrow (6)$$

If ,,b“ is the width of the sample semiconductor, Area ,,A“, thickness,,t“

Area = breadth \times thickness

$$A = b \times t$$

We know that current density

$$J = \frac{I}{A}$$

$$J = \frac{I}{b t} \rightarrow (7)$$

Substituting equations (6) & (7) in (5) we get

$$R_H = \frac{V_H}{B \left[\frac{I}{b t} \right]}$$

Hall coefficient

$$R_H = \frac{V_H \times b}{B \times I} \rightarrow (8)$$

Where V_H = Hall voltage, b = breadth of a semiconductor, B = magnetic field

I = current due to flow of electron

$$V_H = \frac{R_H I}{b} \rightarrow (9)$$

Applications of Hall Effect

1. For determination of type of given semiconductor.

For N-type, Hall coefficient $R_H =$ negative; For P-type, Hall coefficient $R_H =$ Positive

2. To determine carrier concentration „n“ and „p“ ; that is $n = p = \frac{1}{R_H e}$
3. Determination of mobility of charge carriers (μ)

$$\sigma = ne\mu$$

$$\mu = \frac{1}{ne} \sigma = R_H \sigma$$

$$\mu = \left[\frac{-}{B I} \right], \quad \text{Where } \sigma = \text{electrical conductivity}$$

4. For measurement of magnetic flux density „B“ & Hall voltage.
5. To determine the sign of charge carriers, whether the conductivity is due to electrons or holes.

MODULE-III **LIGHT-SEMICONDUCTOR INTERACTION**

Generation and recombination

Carrier generation and recombination occur when an electron makes transition from the valence band to conduction band in a semiconductor, as a result of interaction with other electrons, holes, photons, or the vibrating crystal lattice itself. These processes must conserve both quantized energy and momentum, and the vibrating lattice plays a large role in conserving momentum as, in collisions, photons can transfer very little momentum in relation to their energy.

Recombination and generation are always happening in semiconductors, both optically and thermally, and their rates are in balance at equilibrium. The product of the rate becomes greater than the recombination rate, again driving the system back towards equilibrium. As the electron and hole densities is a constant at equilibrium, maintained by recombination and generation occurring at equal rates. When there is a surplus of carriers the rate of recombination becomes greater than the rate of generation, driving the system back towards equilibrium. Likewise, when there is a deficit of carriers the generation moves from one energy band to another, the energy and momentum that it has lost or gained must go to or come from the other particles involved in the process (e.g. photons, electron, or the system of vibrating lattice atoms). The following models are used to describe generation and recombination, depending on which particles are involved in the process.

Diffusion and Drift

The diffusion of electrons and holes across the junction depend on the concentration gradient of electrons and holes across the junction. If we consider the direction of current flow as x – direction then diffusion current density for electrons is given by

$$J_n(\text{diffusion}) = -e D_n \frac{dn}{dx} \rightarrow (1)$$

Where $\frac{dn}{dx}$ concentration gradient of electron along x —direction
 D_n is the electron diffusion constant

Similarly the diffusion current density of holes is given by

$$J_p(\text{diffusion}) = -e D_p \frac{dp}{dx} \rightarrow (2)$$

Where $\frac{dp}{dx}$ concentration gradient of holes along x —direction
 D_p is the holes diffusion constant

The diffusion of electrons from n-type to p-type leaves the region near the E_B is produced in a direction opposite to that of diffusion current. Hence electrons, the minority charge carriers of p-region drift to n- region and holes, minority carries of n- region drift to p- region. The drift velocity is a propositional to the electric field strength E developed across the barrier i.e. $V = \mu E$

Where μ is a constant known as the mobility of charge carriers

The current density due to electron Drift is given by

$$J_n(\text{drift}) = (e \mu_n n) E \rightarrow (3)$$

Where μ_n is the mobility of the electrons and n is the electron concentration.

The current density due to hole Drift is given by

$$J_p(\text{drift}) = (e \mu_p p) E \rightarrow (4)$$

Where μ_p is the mobility of the holes and p is the holes concentration.

Since diffusion and drift process occur simultaneously the total electron and hole current densities are given by

$$J_n(\text{total}) = J_n(\text{diffusion}) + J_n(\text{drift})$$

$$= -e D_n \frac{dn}{dx} + e \mu_n n E \rightarrow (5)$$

$$J_p(\text{total}) = J_p(\text{diffusion}) + J_p(\text{drift})$$

$$= -e D_p \frac{dp}{dx} + e \mu_p p E \rightarrow (6)$$

At equilibrium, the diffusion and drift current cancel each other for both types of charge carriers and hence

$$J_n(\text{drift}) + J_n(\text{diffusion}) = 0 \rightarrow (7)$$

$$J_p(\text{drift}) + J_p(\text{diffusion}) = 0 \rightarrow (8)$$

Direct and Indirect band gap semiconductors

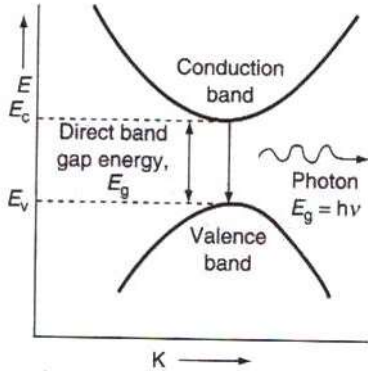
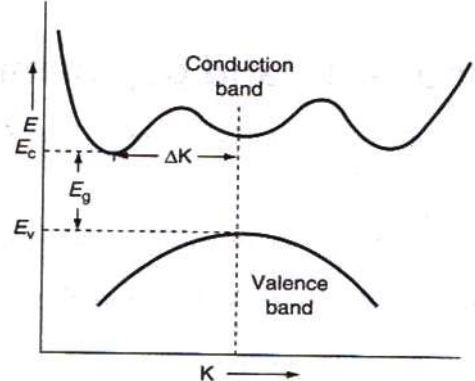
Direct band gap semiconductor	Indirect band gap semiconductor
<p>1. These are impure or Extrinsic or compound semiconductors</p> <p>2. Examples : InP, GaAs, GaAsP etc</p> <p>3.</p>  <p><i>Figure: E-K curve</i></p> <p>4. The minimum energy of Conduction band (CB) and maximum energy of valence band (VB) have the same value of wave vector ,</p>	<p>1. These are pure or intrinsic or elemental Semiconductors</p> <p>2. Examples : Ge, Si</p> <p>3.</p>  <p><i>Figure: E-K curve</i></p> <p>4. The minimum energy of Conduction band (CB) and maximum energy of valence band (VB) have the different values of wave</p>

<p>i.e. $k_1 = k_2$</p> <p>5. Here an electron from CB to can recombine with a hole in VB directly by emitting light of photon of energy 'hν'.</p> <p>6. They are used to fabricate LEDs, Laser Diodes etc.</p> <p>7. Life time (recombination rate) of charge carriers is less.</p> <p>8. Emission of light has energy gap is</p> $E_g = \frac{hc}{\lambda} \text{ eV}$	<p>vector, i.e. $k_1 \neq k_2$</p> <p>5. Here an electron from CB cannot recombine directly with holes in VB. But can recombine through traps by emitting light without emission of photon or light.</p> <p>6. They are used to amplify the signals in electronic devices like rectifiers, transistors, amplifiers etc.</p> <p>7. Life time of charge carriers is more.</p> <p>8. No emission of light. It conducts only Electricity.</p>
--	--

PN Junction

- When a layer of P - type semiconducting material is placed with a layer of N- type semiconducting material in such a way that the atoms of P-type combine with the atoms of N-type across the surface of contact, such a surface junction where combination has occurred is known as PN junction.
- Combined p-type and n-type semiconductors with PN junction formation is known a junction diode or PN diode.
- In practice a PN junction diode may be obtained in any of the following three methods.
 - 1) Grown junction type
 - 2) Fused (or alloyed) junction type and
 - 3) Diffused junction type

1) Grown junction type:

When an extrinsic semiconductor is grown from melt, during the middle of the growth process impurities of opposite kind are added to the melt so that the opposite type of crystal grows further for example: when an n type Si crystal containing phosphorous atoms as pentavalent impurity is grown, the growth process is stopped temporarily and efficient boron atoms are added to the melt as trivalent impurity. This results in growth of p-type thereafter.

2) Fused (or Alloyed) junction type:

In this type p-type and n-type materials are kept in contact and fused together by proper heat treatment to form the junction. For example, a small of dot of indium (p-type material) is pressed on thin water of (n-type)

germanium. During few minutes of heat treatment, indium atoms fuse in to the surface of germanium and produce p-region inside germanium. This p-type region with n-type germanium water forms a p-n junction.

3) Diffused Junction type:

Diffused junctions are formed by impurity diffusion technique. The diffusion process employs either gas diffusion method or solid diffusion method for example in gas diffusion method a wafer of n-type silicon is heated at about 1000°C in a gaseous atmosphere of high concentration gradient the boron atoms. At the temperature due to concentration gradient the boron atom diffuse in to silicon forming p-n junction in solid diffusion process a p-type impurity(say indium) is painted on a n-type substrate and both are heated . Now impurity atoms diffuse into n-type substrate for a short distance and form p-n junction.

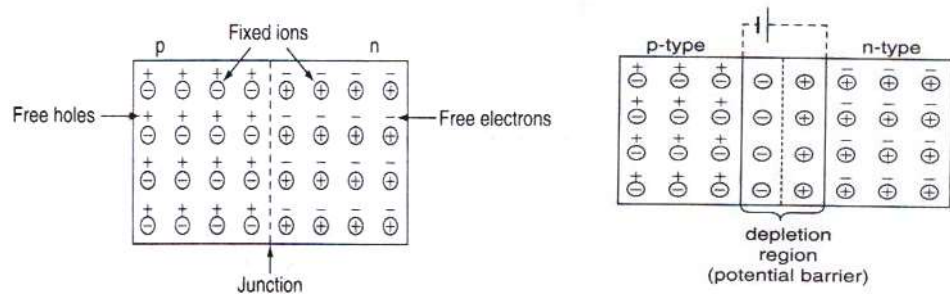

Fig. (a) Newly made p n junction (b) Formation of P N Junction with potential barrier

- The formation PN junction is represented in a figure. Let us consider the formation of a sharp junction when two separate semiconductors of p and n type are brought together.
- The p-type has holes as majority carriers and electrons as minority carriers while n-type has electrons as majority carries and holes as minority carriers.
- When they are joined, in the region of contact the free electrons diffuse from n-region and combine with holes in p-region. This leaves n-region near the boundary positively charged and p-region negatively as a result, electric field E_B appears in a small region W on either side of the junction O . This region is called “Depletion region “. The thickness of this region is in the order of 6×10^{-6} cm.
- Due to electric field E_B potential difference appears across the depletion region and this potential V_B is called “Contact Potential or Barrier Potential or Junction Barrier”.

junction on n-type side positively ionized forming positive space charge region. Similarly the region near the junction on p- type side becomes negatively ionized forming negative space charge region. Hence an electric field

Energy Band Diagram of PN Diode:

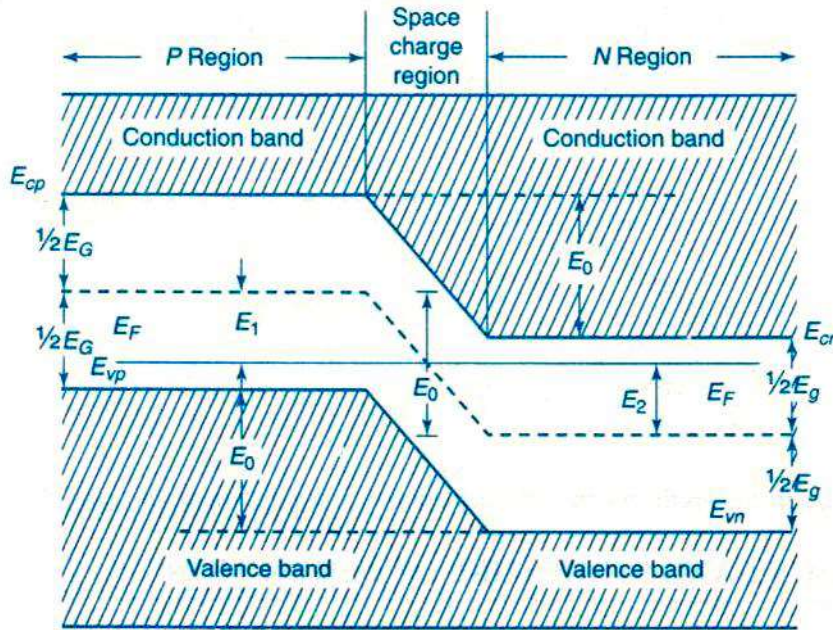

Fig. Energy level diagram of PN junction diode

The contact potential V_B across the junction is due to the potentials of depletion region on n- side denoted by V_n and p – side denoted by V_p

$$\text{ie: } V_B = V_n - V_p \rightarrow (7)$$

The energy levels of valance band, conduction band and Fermi level of both p- type and n- type semi conductors . When Pn junction is formed the Fermi levels become common for both the types formation of potential barrier is represented in fig.

The contact potential separates the energy bands in p—type and n- type crystals. Since there is no net current flow at equilibrium i.e under unbiased condition , it should have common Fermi level. Hence in PN junction diode the valance and conduction band energy levels E_{vp} and E_{cp} of p- type and at higher level compared to the valance and conduction band energy levels E_{vn} and E_{cn} of n-type . The electric field E_B across the junction is given by

$$E_B = E_{vp} - E_{vn} = E_{cp} - E_{cn} = e V_B \rightarrow (8)$$

Biased PN Junction

When the PN junction is unbiased, it is in equilibrium and contact potential $V_B (= V_n - V_p)$ appears across the depletion region.

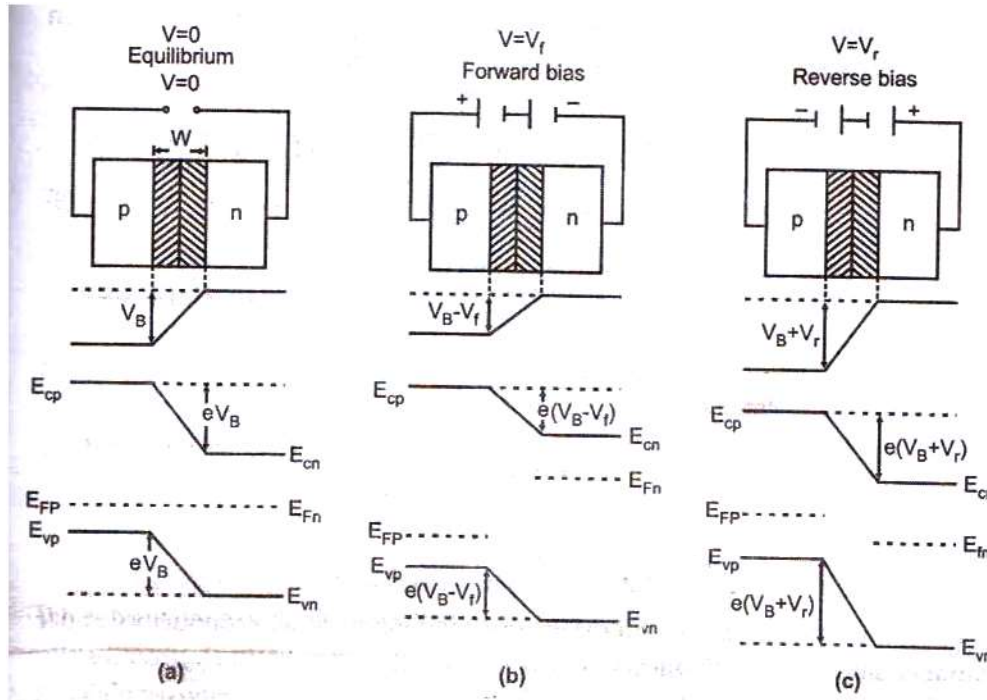

Fig. 9.18: Energy level diagram of biased PN junction (a) Unbiased (b) Forward biased (c) Reverse biased

- If now an external voltage is applied across depletion region such that positive of the source is connected to the p-type side and negative of the source is connected to the n-type then junction is said to be “Forward biased”. This voltage V_f appears across the depletion region. As the contact potential difference V_B acts from n to p the electrostatic potential barrier is lowered and is given by $V_B - V_f$.
- If the external voltage V_r is applied across the depletion region such that the negative of the source is connected to the p- type side and positive of source is connected to the n- type side then the junction is said to be “Reverse biased”. Since this potential acts along V_B , the electrostatic potential barrier increases. And is given by $V_B + V_r$. thus on application of forward bias, the electric field in the transition region reduces and the application of reverse bias increases the electric field in the transition region.
- Since the width of the transition region is proportional to the square root of the electrostatic potential barrier, the width of the transition region decreases under forward bias and increases under reverse bias.

Construction and working of - Light Emitting Diode:

- Emission of radiation from a solid when it is supplied with some form of energy is known as LUMINESCENCE. Whatever the form of energy input to the luminescent material, the final stage in the process is an electronic transition between two energy levels, E_2 and E_1 ($E_2 > E_1$). With the emission of radiation of wavelength λ given by

$$\frac{hc}{\lambda} = E_2 - E_1 = E_g$$

$$\text{i.e) } \lambda = \frac{hc}{E_g} \rightarrow (25)$$

Usually E_1 and E_2 are two groups of energy levels and hence instead of a single wave length emission, a band of wavelength is emitted.

- PN junction diode operated under forward bias gives rise to injection luminescence. Under forward bias, majority carriers from both sides of the junction across the internal potential barrier and enter the other side of the junction where there are minority carriers. This process is called minority carrier injection. These excess minority carriers while diffusing away from the junction undergo radiative recombination with majority carriers emitting photons.
- In reverse bias, no carrier junction takes place and consequently no light is emitted.
- The number of radiative recombination's is proportional to the carrier junction rate and hence to the total current flowing. The current voltage (I-V) relationship for a diode can be written as

$$I = I_0 \left[\exp\left(\frac{eV}{\beta KT}\right) - 1 \right] \rightarrow (26)$$

Where I_0 is the saturation current and β varies between 1 and 2 depending on the

Semiconductor and temperature.

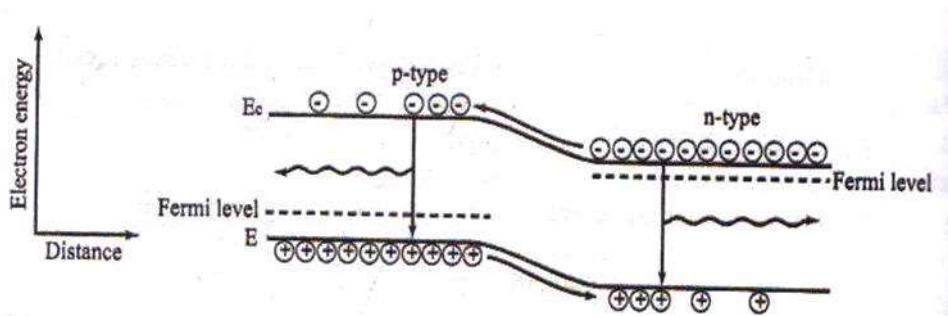

Fig. Injection of minority carriers and subsequent radiative recombination with the majority carriers in a forward biased p-n junction.

- Actually, all semiconductor diodes produce radiation when electrons from the conduction band recombine with holes in the valence band and the emitted radiation is absorbed by the surrounding semiconductor material.

- In an LED, the semiconductor as a high energy gap and the junction is constructed such that the radiation from the junction can escape.

LED Materials

The main requirements for suitable LED materials are

- 1) It must have an energy gap of appropriate width (the energy gaps greater than or equal to about 2eV are required to obtain visible radiation).
- 2) Both p and n types must exist with low resistivities.
- 3) Efficient radiative pathways must be present.

Silicon carbide (SiC) can be doped as both n and p type doping with B, Al, Sc, and Be gives rise to yellow, blue, green and red emission respectively. But since SiC is an indirect band gap material radiative transition efficiency is low. Ga, As, GaP and the ternary alloy $\text{GaAs}_{1-x}\text{P}_x$ are most important III-IV components used.

Gallium arsenide (GaAs)

This is a direct band gap semiconductor with $E_g = 1.443\text{eV}$ ($\lambda_g = 860\text{ nm}$); p-n junctions are readily formed, when GaAs is doped with silicon, based on growing condition, either silicon can replace Ga or As. On replacing Ga it acts as a donor and on As replacement it acts as an acceptor. In silicon doped diodes the emission lies between 910 and 1020 nm. This has high quantum efficiency. These diodes have become standard near-IR emitting devices.

Gallium Phosphide (GaP)

This is an indirect band gap semiconductor with $E_g = 2.26\text{ eV}$ ($\lambda_g = 549\text{ nm}$). Group 5 elements such as N and Bi are commonly used as dopants. Since they have the same valency as the atoms which they replace (P), they do not form normal donor/acceptor states. As the impurity atom differs considerably from the atom it replaces both in the size and its tendency to acquire negative charge, it acts as a trapping centre called ISOELECTRONIC TRAPS. Once a carrier is trapped, the resulting potential attracts a carrier of the opposite charge and emits radiation. The nitrogen isoelectronic traps result in peak emission at about 565 nm i.e. green radiation. At high nitrogen concentrations the temperature emission shifts to 590nm (i.e. yellow). Using Zn, O for double doping, emission at 690nm (i.e. red) is also possible from GaP.

Gallium arsenide phosphide

This material changes from being a direct band gap material (when $x < 0.45$), to being an indirect band gap material (when $x > 0.45$). At changeover point, the $E_g \cong 2.1\text{V}$. From $\text{GaAs}_{0.6}\text{P}_{0.6}$; red emission is obtained. From $\text{GaAs}_{0.35}\text{P}_{0.85}$; N, orange and yellow emission are obtained respectively.

Gallium Aluminum arsenide ($\text{Ga}_x\text{Al}_{1-x}\text{As}$)

In hetero junction formed between n-type $\text{Ga}_{0.3}\text{Al}_{0.7}\text{As}$ and p-type $\text{Ga}_{0.6}\text{Al}_{0.4}\text{As}$ (with zinc as dopant). Radiative recombination takes place and emission with higher efficiency occurs at 650nm. When Si is used as dopant to

form both donor and acceptor states, by varying Al concentration, band gap can be varied and emission between 870 and 890 nm can be obtained.

Construction of LED

- The typical construction of LED is shown in the figure. LED has to be designed and constructed in such a way that most of the radiative recombinations takes place from the side of the junction nearest to the surface so that loss due to reabsorption is minimized

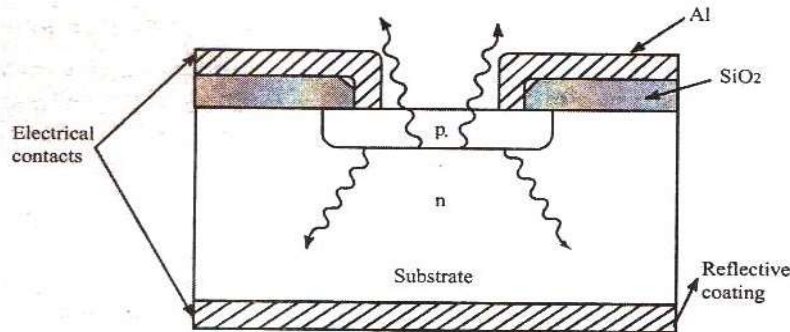

Fig. Construction of typical LED

- For this p-n junction layer has to be parallel and closer to the surface layer. The LED is constructed on a GaP n- doped substrate. A thin epitaxial p- doped GaP layer is grown on the top of this substrate.
- Electrical contacts are made leaving as much of the upper surface of the p- material uncovered.
- The recombination takes place and radiation is generated between p and n layers i.e. p-n junction. Since Gap layer is transparent, the radiation escapes through the top layer.
- To the bottom electrode a reflective layer is added to improve the efficiency.
- Although the internal quantum efficiencies of some LED materials can approach 100%, the external efficiencies are much lower. The main reason is that most of the emitted radiation strikes the material interface at angles greater than critical angle and so lost due to total internal reflection. Since the III-IV materials have high refractive indices, the critical angles are small.
- For example in GaP and air interface, since the critical is 17° , the rays' incident at an angle greater than this are lost.
- There are two ways of improving the situations; the first is to ensure that most rays strike surface at angles less than critical angle. This is achieved shaping in the semiconductor/ air interface in to a hemisphere; in this the p- material is made in to a hemisphere dome. More radiation then strikes the semiconductor/ air interface at less than the critical angle and hence are not lost. This technique is too difficult and more expensive.
- The second technique is to encapsulate the junction in a transparent plastic medium of high refractive index. Moulding the plastic in to an approximately hemispherical shape, loss at the plastic / air interface is minimized.

- Intensity of the emission is an important optical parameter of an LED. The relative intensity increases with LED current. LED output is not monochromatic but contains considerable band width (\cong 30 to 40 nm) around the central wavelength.
- Output intensity is temperature dependant. If the temperature increases by 25° C, the intensity decreases by 25%.
- Another very important characteristic of an LED is its fast response time, typically 90ns for yellow and red and 500ns for green. This response time makes LEDs suitable as a source in communication links.

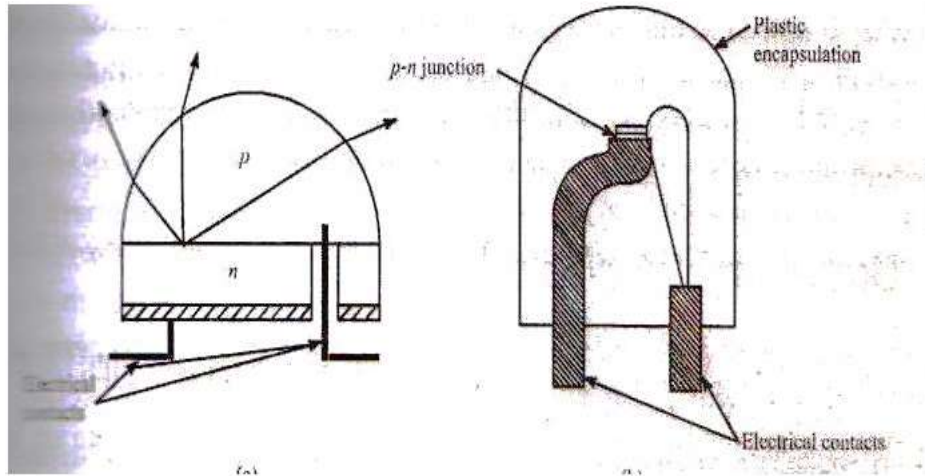

Fig. Two methods used to reduce reflection losses in LEDs.

- (a) Hemispherical dome made of p material and
 (b) Plastic mould in hemispherical shape.

Advantages of LEDs in electronic Display

- 1) Output is bright and the intensity can be controlled easily by varying current.
- 2) They can be operated over a wide range of temperature 0 to 70° C
- 3) Very fast response time in the order of ns and hence very useful as source for optical Communication.
- 4) Available in different colors.
- 5) Very small in size and hence can be closely packed for high density display.
- 6) As long life (about 10^5 hours) and high degree reliability.
- 7) The viewing angle is not limited.
- 8) Very rugged and hence suitable for any environment.

P - N junction as a photo detector – Junction Photodiode

- The function of the photo diode junction is the opposite an LED function. In an LED, photons are released in response to the current flow through the junction. In a photo diode, the photons are absorbed resulting in the generation of the carriers that manifest as current through the junction.
- In p-type material holes are majority carriers and in n-type material electrons are minority carriers on formation of a junction, on either side of the junction they diffuse, combine and neutralize one another. Hence a region called DEPLETION REGION is formed on the either side of the junction when there are no free carriers.

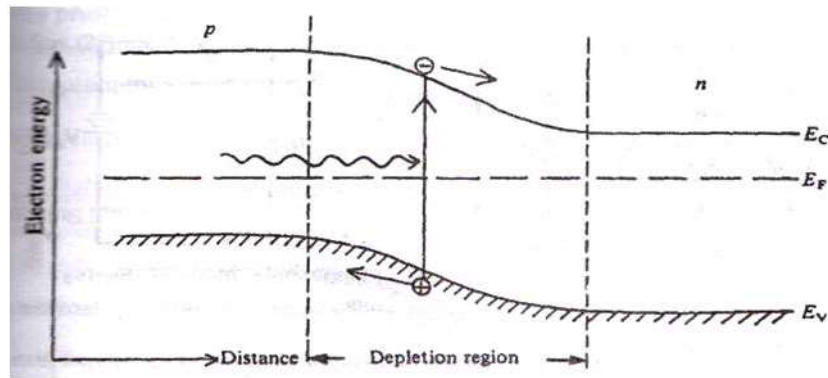

Fig. The generation & subsequent separation of an electron – hole pair by photon absorption within the depletion region of a p – n junction

- Only ionized atoms of opposite polarity remain i.e in p- type material negatively ionized atoms and in n- type material positively ionized atoms remain. This action generates a barrier voltage that opposes further diffusion of the free carriers in to the junction.
- When an electron – hole pair is generated by photon absorption with this region, the internal field causes the electron and hole to separate. This charge separation can be detected in two ways. If a device is left an open circuit, an externally measurable potential appear between p and n regions. This is known as the PHOTO VOLTAIC

MODE of operation. Instead, if we short circuit the device externally, an external current flows between the p and n regions. This is known as the PHOTOCONDUCTIVE MODE of operation. Under photoconductive mode it is usually operated under reverse bias conditions.

- When forward bias is applied to the junction, it opposes the barrier voltage, reduces the width of the deflection region and increases the junction capacitance. When the bias reaches the barrier voltage, the depletion region is eliminated and the junction becomes conductive.
- When reverse bias is applied, the depletion region is widened, the junction capacitance reduced, and the junction says non-conductive. The reverse bias junction can conduct current when free carriers are generated in the junction by radiation of sufficient energy.

Advantages of Photoconductive mode:

The following are the advantages of photo conductive mode:

- 1) Linear response
- 2) Faster response
- 3) Better stability and
- 4) Greater dynamic range.

Construction of a Junction Photodiode

- The most common semiconductor material used for photo diodes is silicon. It has an energy gap of 1.14eV. It provides excellent photodiodes with quantum efficiencies up to 80% at wave length between 0.8-0.9 μ m. It shows a typical silicon photodiode structure for photo- conductive operation.
- A junction is formed between heavily doped p- type material (p^+) and fairly lightly doped n- type material so that the depletion region extends well into the n- material . The p^+ layer is made fairly thin. Metallic contracts can be made directly to the p^+ material but to obtain an ohmic contact to the n – material an intermediate n^+ layer is formed.

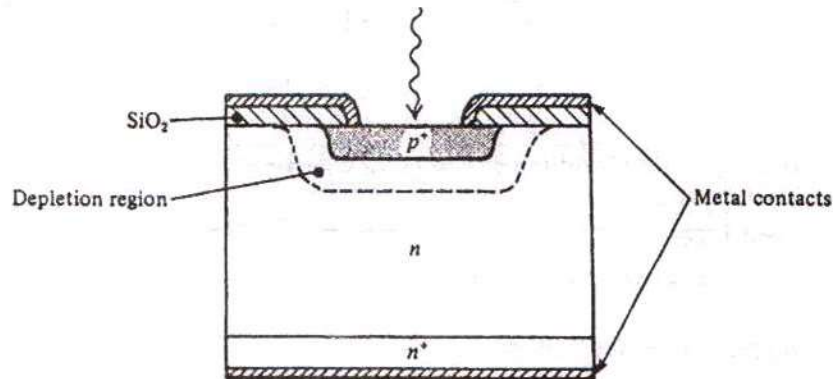

Fig. Typical silicon photo diode structure for photoconductive operation

- The penetration of photons through the layer depends on the wave length of radiation shorter wave length (ultra violets) are absorbed at the surface, while the longer wave length (infrared) can penetrate deep in to the structure .
- A wide response photo diode should therefore have a thin p- layer and a thick depletion layer so that most of the photons are absorbed in the depletion layer. Hence the response time of the diode is mainly determined by the thickness of the depletion layer.
- The thickness of the layer can be controlled by the doping level of the n- layer lower doping level increase the thickness of the depletion layer and reduce the diode capacitance . This technique is used in the PIN type photo diode, where a thick layer of low doped and highly resistive n- type material is inserted between the p and n- layers. This middle layer is called the intrinsic or I- layer, hence the name PIN diode.

- The PIN diode has a relatively thick depletion layer which, with modest reverse bias of 5v , can be extended to the bottom of the intrinsic layer . The result is a photo diode with a faster response time and an extended spectral response. The spectral response of the junction photo diodes ranges from ultraviolet to infrared. It depends mainly on the semiconductor material, and also on the junction design and window material.
- The silicon photo diode is one of the most popular of all radiation detectors in the wavelength range 0.4 to 1 μm . it has the following features.
 - (1) High quantum efficiency
 - (2) Small size
 - (3) Good linearity of response.
 - (4) Large band width
 - (5) Simple biasing requirements and
 - (6) Relatively low cost.

Solar Cell

Definition

Solar cell is a P – N junction semiconducting diode which converts light energy into

electrical energy. The energy of light is transmitted by *photons*, small packets or quanta of light. Electrical energy is stored in electromagnetic fields, which in turn can make a current of electrons flow. Thus a solar cell converts light, a flow of photons, to electric current, a flow of electrons.

Construction

There are several technologies to construct a solar cell. One of them is Quantum Dot (QD) Solar Cells. These are built up of a semiconductor (silicon) coated with a very thin layer of Quantum dots. Quantum dots is just a fancy name of crystals in the size range typically a few nanometers in diameter. These crystals are mixed into a solution and placed on a piece of silicon which is rotated really fast. The crystals are then spread out due to the centrifugal force. The reason these quantum dots are given so much attention is that normally one photon will excite one electron creating one electron-hole pair. The energy loss is the original energy of the photon minus the energy needed to excite the electron(also called the band gap). However, when a photon hits a quantum dot made of the same material, there may be several electron-hole pairs created, typically 2-3, but 7 has been observed.

Working principle

The solar cell is basically a p – n junction diode that converts sunlight directly to electricity. The working

principle of solar cells is based on the *photovoltaic effect*. In general, the photovoltaic effect means the generation of a potential difference at the junction of two different materials in response to visible or other radiation.

The basic processes behind the photovoltaic effect are

1. Generation of the charge carriers due to the absorption of photons in the materials that form a junction,
2. Subsequent separation of the photo-generated charge carriers in the junction,
1. Collection of the photo-generated charge carriers at the terminals of the junction.

The solar cell works in three steps

1. Photons in sunlight hit the solar panel and are absorbed by semiconducting materials, such as silicon.
2. Electrons (negatively charged) are knocked loose from their atoms, causing an electric potential difference. Current starts flowing through the material to cancel the potential and this electricity is captured. Due to the special composition of solar cells, the electrons are only allowed to move in a single direction.
3. An array of solar cells converts solar energy into a usable amount of direct current (DC) electricity.

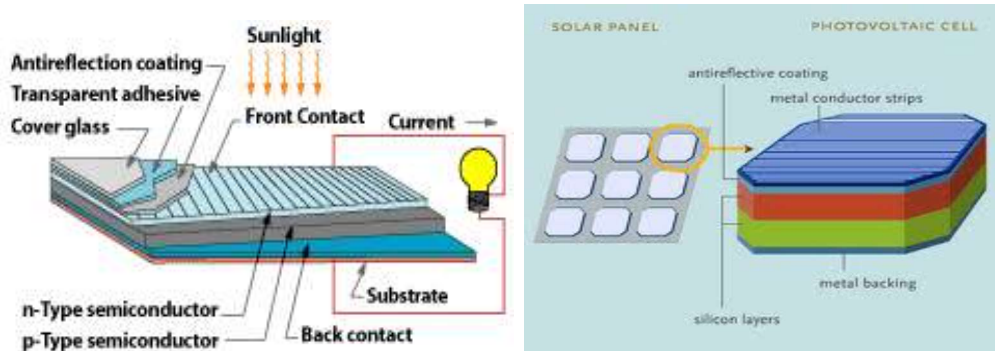

Fig. A typical solar cell consists of a glass or plastic cover, an antireflective coating, a front contact to allow electrons to enter a circuit, a back contact to allow them to complete the circuit, and the semiconductor layers where the electrons begin and complete their journey.

Explanation

The action of the solar cell is explained as follows:

- When a p – n junction diode is exposed to light, the photons are absorbed and electron pairs are generated in both in both the p – side and n – side of the junction, as shown in the figure below. The electrons and holes that are produced over a small distance from the junction reach the space charge region X by diffusion.

- The electron – hole pairs are then separated by the strong barrier field that exists across the region X. The electrons in the p – side slide down the barrier potential to move to the n – side while the holes in the n – side move towards the p – side.
- When the p – n junction diode is open circuited, the accumulation of electrons and holes on the two sides of the junction gives rise to an open – circuit voltage V_0 . If a load resistance is connected across the diode, a current will flow in the circuit. The maximum current, called the short – circuit current is obtained when an electric short is connected across the diode terminals. Note that the current flows as long as the diode is exposed to sunlight and the magnitude of the current is proportional to the light intensity.
- Solar cells are used extensively in satellites and space vehicles as most important long duration power supply. Solar cells are constructed with Silicon, Germanium, Gallium arsenide, Cadmium sulphide and with many other semiconductors, and in various device configurations.

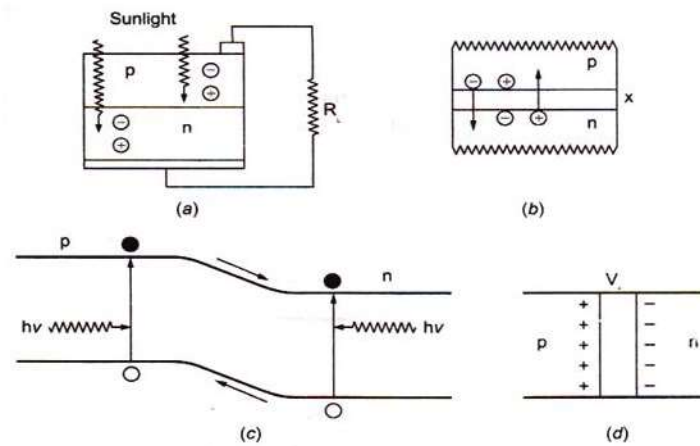

Fig. (a) p-n junction solar cell with load resistance, R_L (b) Diffusion of electrons & Holes (c) Energy band diagram of solar cell (d) Formation of the open circuit voltage V_0

MODULE-IV

ENGINEERED ELECTRIC AND MAGNETIC MATERIALS

Introduction

- Dielectrics are insulating materials. In dielectrics, all electrons are bound to their parent molecules and there are no free charges.
- Even with normal voltage or thermal energy electrons are not released.
- Dielectrics are non metallic materials of high specific resistance and have negative temperature coefficient of resistance.
- Dielectrics are electrical insulators. They possess high resistivity values within the range $10^6 \Omega\text{m}$ to $10^{16} \Omega\text{m}$. Under high voltage bias, they allow very little current. They with stand for very high voltages. The conduction is mostly associated with ionic motion through defects or hopping of charges. They have no free charges. The electrical properties of a dielectric are associated with inherent property of possessing electric dipoles.
- Dielectrics are the materials having electric dipole moment permanently or temporarily by applying electric field. These are mainly used to store electrical energy and as electrical insulators. All dielectrics are electrical insulators. But all electrical insulators need not be dielectrics. For example

the vacuum is a perfect insulator. But it is not a dielectric. The study of dielectrics is essentially study of insulators.

Basic Definitions

Electric dipole

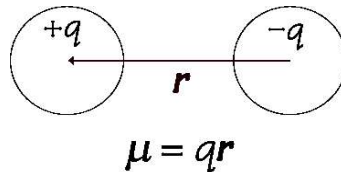

Fig. Electric dipole

Two equal and opposite charges separated by a distance 'r' constitute a dipole.

Electric dipole moment (μ)

The product of charge and distance between two charges is called electric dipole moment.

$$\mu = q \times r$$

Units: coulomb - meter or Debye.

$$1 \text{ Debye} = 3.33 \times 10^{-30} \text{ coulomb - meter}$$

Non-polar dielectrics

Mono atomic materials are made up of atoms. The centre of gravity of negative charge and the centre of gravity of positive charge of an atom coincide. That means even though there are two equal and opposite charges are not separated.

Their dipole moment is zero.

$$\therefore \mu = q \times r = q \times 0 = 0$$

Such dielectrics are called Non- polar dielectrics.

Non-Polar Molecule

- Consider an atom. The positive charge of nucleus may be concentrated at a single point called as centre of gravity of the positive charge.
- The negative charge of electrons may be supposed to be concentrated at a single point called as Center of gravity of the positive charge.
- When the two centre of gravity coincide, the molecule is known as Non-polar molecule. The Non-polar molecules have symmetrical structure and zero electric dipole moment.
- Examples: H₂, N₂, O₂, CO₂, Benzene.

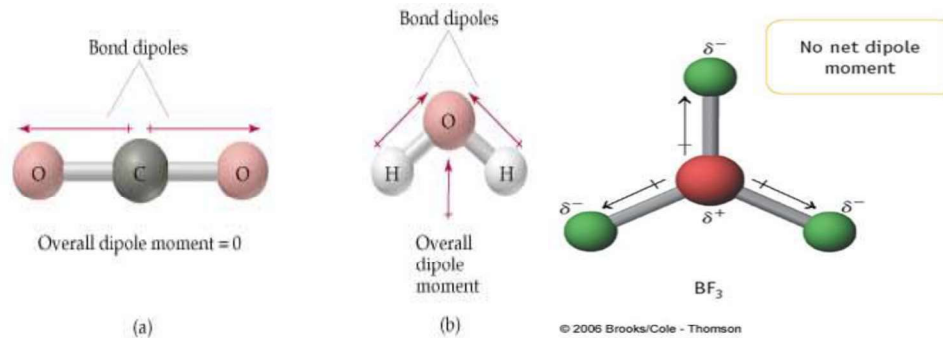

Fig. Non polar molecules with zero dipole moment ($\mu=0$)

- The electric dipole moment has a direction from positive charge to negative charge.

Polar dielectrics

- In polyatomic molecules, the center of gravity of negative charge distribution may not coincide with the center of positive charge distributions.
- There is an effective separation between centers of negative and positive charge distributions.
- The molecule has a net dipole moment. Such dielectrics are called Polar dielectrics.

Polar Molecules

They have unsymmetrical structure and have a permanent electric dipole moment. The Center of gravity of positive and negative charges do not coincide, the molecule is called as polar molecule.

e.g.:- H_2O , HCl , CO , N_2 , NH_3 etc.

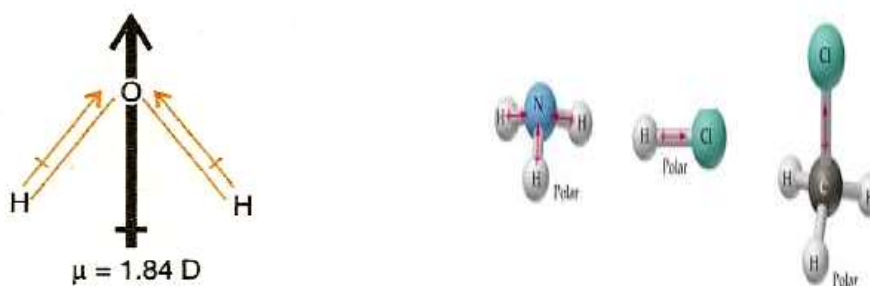

Fig. Polar molecules with net dipole moment ($\mu \neq 0$)

Dielectric constant ϵ_r (or) Relative permittivity of the medium

- It is the ratio between the permittivity of the medium and the permittivity of free space.

$$\epsilon_r = \frac{\epsilon}{\epsilon_0} \quad . \quad \text{It has no units.}$$

- ϵ_r is also called as relative permittivity of the medium. It is a measure of polarization in the dielectric material.

$\epsilon_r = \epsilon_0 \epsilon_r$ where ϵ = absolute permittivity of the medium
 Where ϵ_0 = permittivity of free space = 8.854×10^{-12} F/m

Electric Polarization

When a dielectric substance is placed in an electric field, then positive and negative charges are displaced in opposite direction.

- The displacement of charges produces local dipoles.
- This process of producing dipoles by the influence of electric field is called electric polarization.

$$\text{dielectric Polarization} = P = \frac{\text{electric dipole moment}}{\text{volume}}$$

$$P = \frac{\mu}{V}$$

$$P = \frac{q \times l}{A \times l} = \frac{q}{A}$$

$$P = \frac{\text{charge}}{\text{area}} = \text{surface charge density } \sigma'$$

Polarizability (α)

The average dipole moment μ is directly proportional to the electric field (E) applied.

$$\mu \propto E$$

$$\mu = \alpha E$$

$$\alpha = \text{Polarizability} = \frac{\mu}{E} \text{ Farad/m}^2$$

Polarization Vector (P)

It is defined as the average dipole moment per unit volume of a dielectric. If 'N' molecules are present per unit volume,

$$\text{Then polarization vector } P = \frac{N \mu}{\text{volume}}$$

$$P = N \mu \text{ coulomb/m}^2$$

Electric flux density (or) Electric displacement (D)

The number of electric lines of forces received by unit area is called Electric flux density.

$$D \propto E$$

$$D = \epsilon E$$

$$\text{But } \epsilon = \epsilon_0 \epsilon_r$$

$$D = \epsilon_0 \epsilon_r E$$

Relation between Polarization (P), Electric field (E) & Dielectric constant ϵ_r

We know that electric flux density 'D' is written as

$$D = \epsilon E \rightarrow (1)$$

Where ϵ = absolute permittivity of medium

E = electric field

$$\text{Where } E = \epsilon_0 \epsilon_r \rightarrow (2)$$

Hence substitute (2) in (1)

$$D = \epsilon_0 \epsilon_r \rightarrow (3)$$

Where ϵ_0 = permittivity of free space = 8.854×10^{-12} F/m

ϵ_r = Dielectric constant or relative permittivity of the medium.

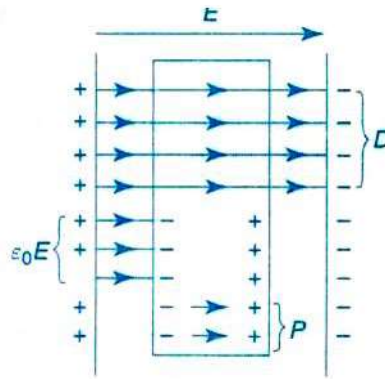

Fig. Electric lines of forces in a polar dielectric

If 'P' is the polarization of the dielectric material due to the applied electric field (E), then the flux density 'D' is equal to the flux density in vacuum plus polarization of the material

$$\therefore D = \epsilon_0 E + P \quad \rightarrow (4)$$

equating equations (3) & (4)

$$\epsilon_0 \epsilon_r E = \epsilon_0 E + P$$

$$P = \epsilon_0 E [\epsilon_r - 1]$$

$$P = \epsilon_0 \epsilon_r E - \epsilon_0 E \quad \rightarrow (5)$$

Put $[\epsilon_r - 1] = \chi$ $\rightarrow (6)$

Where χ = electric susceptibility

From equation (5) & (6)

$$\Rightarrow P = \epsilon_0 E \chi$$

$$\chi = \frac{P}{\epsilon_0 E} \quad \rightarrow (7)$$

Conclusion:

$$\Rightarrow P = E [\epsilon_r - 1]$$

$$\chi = \epsilon_r - 1$$

$$\chi = \frac{P}{\epsilon_0 E}$$

Electric Susceptibility (χ)

The electric susceptibility ' χ ' is defined as the ratio of polarization vector to the applied electric field 'E'.

$$\chi = P / \epsilon_0 E$$

χ has no units.

$$\Rightarrow P = \chi \epsilon_0 E$$

Where $\chi = \epsilon_r - 1$

Dielectric strength

It is defined as the minimum voltage required producing dielectric break down.

Dielectric strength decreases with rising of temperature, humidity and age of the material.

Non-Polar Dielectric in an electric field

When a dielectric is placed in an electric field, say between the plates of a charged Condenser; the positive and negative charges are re oriented i.e. the center of gravity of positive charges is pulled towards the negative plate of the condenser and vice versa. Thus the net effect of the applied field is to separate the positive charges from the negative charges. This is known as Polarization of dielectric. The dielectrics which are polarized only when they are placed in an Electric field are called Non-polar dielectrics.

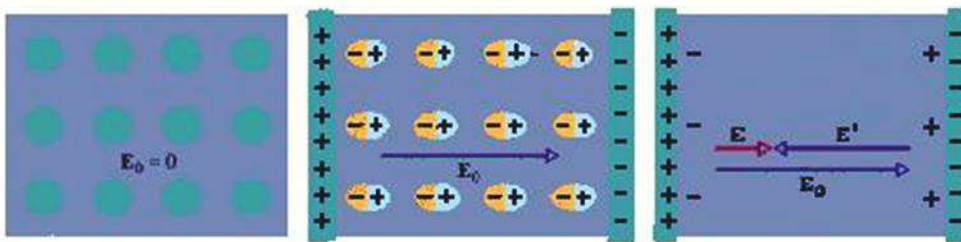
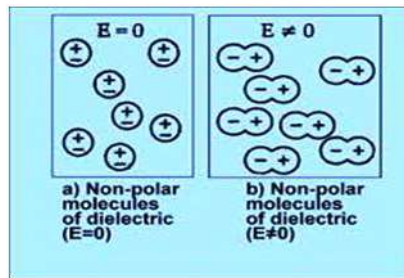

Fig. (a) non polar dielectric in $E=0$ (b) Non polar dielectric when 'E' is applied
(c) Totally polarized non polar dielectric with net field

Thus if the dielectric is placed in an electric field, induced surface charges appear which tend to weaken the original field within the dielectric. That means E' opposes the original field E_0 .

Polar dielectric in electric field

We know that polar dielectric have permanent dipole moments with their random orientations. In the presence of an electric field, the partial alignment of dipoles takes place.

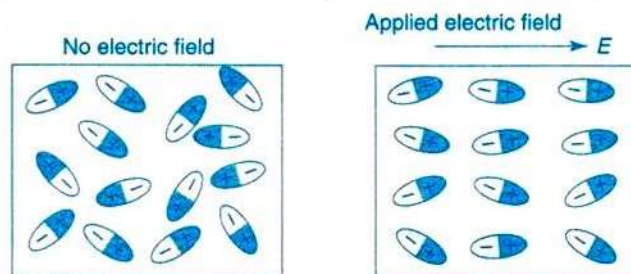

Fig. Polar dielectric orientation without field and with field.

Polar dielectrics already possess some dipole moment inside due to the presence of permanent atomic dipoles. But these are randomly oriented when no field is applied.

Their dipole moment and polarization increases since dipoles align along the field direction gives some extra polarization. Hence

$$P = \left\{ \begin{array}{l} \text{Polarization already} \\ \text{Existing due to permanent} \\ \text{dipoles} \end{array} \right\} + \left\{ \begin{array}{l} \text{Polarization induced} \\ \text{due to electric} \\ \text{field} \end{array} \right\}$$

$$P = P_p + P_i$$

The Local field (or) Internal field E_i (or) E_{local}

Definition: In dielectric solids, the atoms or molecules experienced not only the external applied electric field but also the electric field produced by the dipoles. Thus the resultant electric field acting on the atoms or molecules of dielectric substance is called the “Local field or an internal field.”

Derivation:

Consider a dielectric material placed in an External field ‘ E_1 ’, placed between the parallel plates of a capacitor. As a result opposite type of charges are induced on the surface of dielectric.

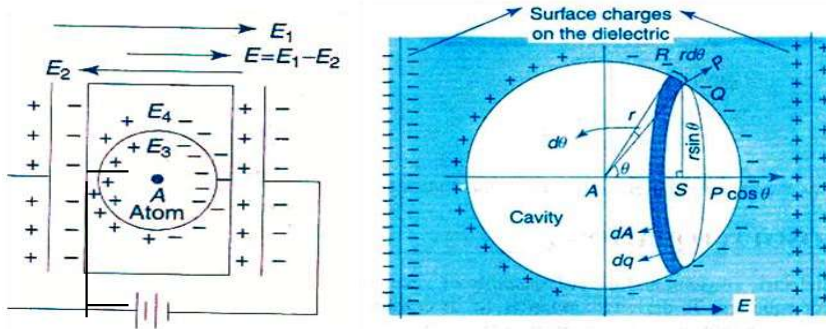

Fig. (a) Polar dielectric in electric field (b) Enlarged view of spherical cavity

Imagine a small spherical cavity of radius ‘r’. In this sphere inside dipoles are present. Consider a dipole at the center of spherical cavity. This dipole experiences the following fields, in addition to the externally applied field ‘ E_1 ’.

The total internal field experienced by the dipole

$$E_{local} = E_i = E_1 + E_2 + E_3 + E_4 \quad \rightarrow (1)$$

Where E_1 = External applied field. Here,

- (a) The field ‘ E_2 ’ produced by induced charges on the dielectric sample near the surface.
- (b) The field E_3 arising from dipoles inside the sphere. E_3 depends on crystal symmetry. [For isotropic materials $E_3=0$]
- (c) The field E_4 is due to polarization of charges on the surface of spherical cavity. It is called the Lorentz cavity field.

The surface charge density on the surface of the spherical cavity is $P \cos \theta$.

If ‘ds’ is the area of the surface element shaded in figure shown.

Then charge on the surface element (q_1) is
 = (normal component of polarization) x (area of the surface element)
 $q_1 = (P \cos \theta) (ds)$ →(2)

Let a test charge $q_2 = q$ placed at the center of cavity.
 From coulombs' law, the force experienced between the surface charges.

$$dF = \frac{1}{4\pi} \frac{q_1 q_2}{r^2} dF = \frac{1}{4\pi\epsilon_0} \frac{(P \cos \theta ds) \cdot q}{r^2}$$

$$\frac{dF}{q} = \left[\frac{1}{4\pi\epsilon_0} \right] \left[\frac{P \cos \theta ds}{r^2} \right]$$
 → (3)

The resulting electric field $E_4 = \frac{dF}{q} = \left[\frac{1}{4\pi\epsilon_0} \right] \left[\frac{P \cos \theta ds}{r^2} \right]$ → (4)

The electric field is resolved into two components:
 One component is along the direction of 'P' & other perpendicular to it.
 The Perpendicular components cancel themselves out leaving only the horizontal components. Hence the sum of all such horizontal components of electric field for the whole Surface is:

$$E_4 = \int dE_4 \cos \theta = \int \frac{1}{4\pi\epsilon_0} \frac{(P \cos \theta)(\cos \theta ds)}{r^2}$$
 → (5)

The surface area of the ring $ds = 2\pi r^2 \sin \theta d\theta$ → (6)

Substitute (6) in (5)

$$E_4 = \frac{1}{4\pi\epsilon_0} \int \frac{P \cos^2 \theta 2\pi r^2 \sin \theta d\theta}{r^2}$$

Limits are $\theta = 0$ to π

$$E_4 = \frac{P}{2\epsilon_0} \int_0^\pi \cos^2 \theta d\theta$$
 → (7)

Let $\cos \theta = z$

$-\sin \theta d\theta = dz$ & Limits are $z = 1$ to $z = -1$

Equation (7) becomes $E_4 = \frac{P}{2\epsilon_0} \int_1^{-1} z^2 (-dz)$

$$E_4 = \frac{-P}{2\epsilon_0} \int_{+1}^{-1} z^2 dz$$

$$= \frac{-P}{2\epsilon_0} \left[\frac{z^3}{3} \right]_1^{-1} = \frac{+P}{3\epsilon_0}$$

$$E_4 = \frac{P}{3\epsilon_0}$$
 → (8)

Substitute the value of E_4 in equation (1)

Total internal field (or) local field

$$E_i = E_{loc} = E_1 + E_2 + E_3 + E_4$$

Here $E_3 = 0$

$\therefore E_i = E_1 + E_2 + E_4$

Let $E_1 + E_2 = E$

$\Rightarrow E_i = E + E_4$

$$E_i = E + \frac{P}{3\epsilon_0}$$

Clausius – Mosotti relation

This makes the relation between microscopic & macroscopic quantities of Polarization. From Polarization Vector

$$P = N \mu \rightarrow \quad \rightarrow (1)$$

Where N = No. of molecules per unit volume, μ = average dipole moment

$$\mu = \alpha E = \alpha E_i \quad \rightarrow (2)$$

$$\text{Where } E_i = \text{local (or) internal field} = \frac{P}{3\epsilon_0} \quad \rightarrow (3)$$

Substituting (2) & (3) in (1)

$$\begin{aligned} P &= N \alpha E_i \\ P &= N \alpha \left[E + \frac{P}{3\epsilon_0} \right] \\ P &= N \alpha E + \frac{N\alpha P}{3\epsilon_0} \\ \left[P - \frac{N\alpha P}{3\epsilon_0} \right] &= N\alpha E \\ P \left[1 - \frac{N\alpha}{3\epsilon_0} \right] &= N\alpha E \\ P &= \frac{N\alpha E}{\left[1 - \frac{N\alpha}{3\epsilon_0} \right]} \quad \text{---(4)} \end{aligned}$$

$$\text{We know that } P = \epsilon_0 E [\epsilon_r - 1] \quad \rightarrow (5)$$

Equating (4) & (5)

$$\begin{aligned} \frac{N\alpha E}{\left(1 - \frac{N\alpha}{3\epsilon_0} \right)} &= \epsilon_0 E [\epsilon_r - 1] \\ \frac{N\alpha}{\epsilon_0 [\epsilon_r - 1]} &= \left(1 - \frac{N\alpha}{3\epsilon_0} \right) \\ \frac{N\alpha}{\epsilon_0 [\epsilon_r - 1]} &= 1 - \frac{N\alpha}{3\epsilon_0} \\ \frac{N\alpha}{\epsilon_0 [\epsilon_r - 1]} + \frac{N\alpha}{3\epsilon_0} &= 1 \\ 1 &= \frac{N\alpha}{3\epsilon_0} \left[\frac{3}{\epsilon_r - 1} + 1 \right] \\ 1 &= \frac{N\alpha}{3\epsilon_0} \left[\frac{3 + \epsilon_r - 1}{\epsilon_r - 1} \right] \\ 1 &= \frac{N\alpha}{3\epsilon_0} \left[\frac{\epsilon_r + 2}{\epsilon_r - 1} \right] \\ \frac{\epsilon_r - 1}{\epsilon_r + 2} &= \frac{N\alpha}{3\epsilon_0} \end{aligned}$$

$$\text{If } \left\{ \begin{array}{l} \alpha_m = \text{molar polarization} \\ N_A = \text{Avagadro number} \\ \rho = \text{density} \\ M = \text{molecular weight} \end{array} \right.$$

$$\Rightarrow N = \frac{\rho N_A}{M}$$

\Rightarrow From Clausius Mosotti relation

$$\begin{aligned} \frac{[\epsilon_r - 1]}{[\epsilon_r + 2]} &= \frac{N_A}{3\epsilon_0} \\ \frac{[\epsilon_r - 1]}{[\epsilon_r + 2]} &= \frac{\rho N_A}{3\epsilon_0} \left[\frac{\alpha_m}{3\epsilon_0} \right] \end{aligned}$$

Types of Polarization

Polarization is the process of inducing dipole moment in a molecule. There are four types of polarization. They are:

- (1) Electronic Polarization
- (2) Ionic Polarization
- (3) Orientation (or) Dipolar Polarization
- (4) Space charge polarization

Electronic Polarization:

Definition:

When an electric field is applied on a dielectric material then all the positive nuclei of atoms move in the field direction and all the negative electron cloud of atoms move in opposite directions, hence dipoles are formed to produce dipole moment.

- The electron cloud readily shifts towards the positive end of the field. The extent of shift by electrons is proportional to field strength.
- Hence dipole moment is the product of charge and shift distance.

Expression for Electronic Polarizability α_e

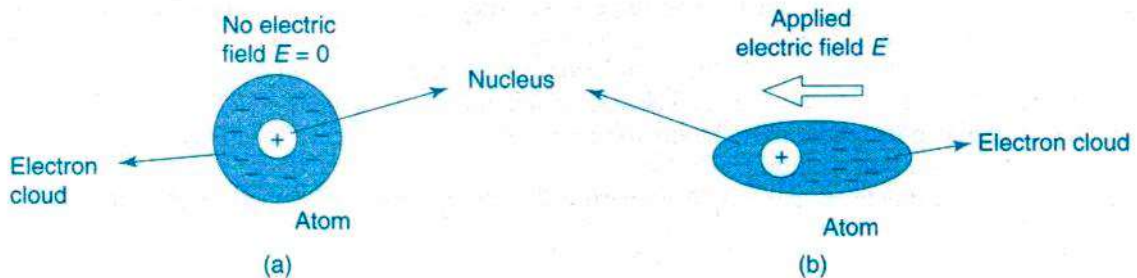

Fig. (a) Un polarized atom in the absence of field
(b) Electronic polarization due to distortion of electron cloud by the field E

- Consider an atom of dielectric material such that its atomic radius is 'R' & atomic number 'Z'. When no field is applied the charge centers of electron cloud and positive nucleus are at the same point & hence there is no dipole moment.
- Suppose an atom is placed in an electric field of strength E, due to Lorentz force the positive nucleus move towards the field direction and electron cloud will move in opposite direction of the field.
- When nucleus and electron cloud are displaced from their equilibrium positions, an attractive Coulomb force act between them to maintain original position. But Lorentz force will tend to separate them from their equilibrium position.

- When these forces are equal and opposite produces a net dipole moment.

Let the displacement between centers of nucleus and electron could be 'X'.

Let 'ze' is charge of nucleus.

'-ze' is charge of electron cloud in a sphere of radius 'R'.

⇒ The charge density due to negative electron cloud of radius R (E=0) is

$$\rho = \frac{(-ze)}{\left(\frac{4}{3}\pi R^3\right)}$$

$$\rho = \frac{-3}{4} \frac{ze}{\pi R^3} \quad \rightarrow (1)$$

Lorentz force which tends to separate positive nucleus from negative electron cloud is

$$= (-ze) E \quad \rightarrow (2)$$

Coulomb force which tends force of attraction between them is

$$\Rightarrow (ze) \frac{[\text{charged enclosed in sphere of radius } x]}{4\pi\epsilon_0 x^2} \quad \rightarrow (3)$$

But the charge enclosed in the sphere of radius 'x' due to electrons of radius 'x'

$$= \frac{4}{3} \pi x^3 \rho$$

$$= \frac{4}{3} \pi x^3 \left[\frac{-3}{4} \frac{ze}{\pi R^3} \right] \{\text{from equation (1)}\}$$

$$= \frac{-zex^3}{R^3} \quad \rightarrow (4)$$

Substitute equation (4) in (3) we get

$$\text{Coulomb force} = \frac{(ze) \left[\frac{-zex^3}{R^3} \right]}{4\pi\epsilon_0 x^2}$$

$$\text{Coulomb force} = \frac{-z^2 e^2 x}{4\pi\epsilon_0 R^3} \quad \rightarrow (5)$$

In equilibrium position coulomb & Lorentz forces are equal.

∴ Comparing equations (5) & (2) we get

$$\frac{-z^2 e^2 x}{4\pi\epsilon_0 R^3} = (-ze) E$$

$$\text{Hence electron cloud displacement 'X'} = \left[\frac{4\pi\epsilon_0 R^3}{ze} \right] E \quad \rightarrow (6)$$

The two charges (+ze) of nucleus & (-ze) of electron cloud are displaced through 'X'. Hence
electric dipole moment is $\mu_e = | \text{charge} | \times (\text{displacement})$

$$= | ze | (X)$$

$$= (ze) \left(\frac{4\pi\epsilon_0 R^3}{ze} \right) E \quad [\text{i. e from equation (6)}]$$

$$\mu_e = (4\pi\epsilon_0 R^3) E \quad \rightarrow (7)$$

We know that electronic polarizability

$$\alpha_e = \frac{\text{dipole electric moment}}{\text{electric field}}$$

$$\alpha_e = \frac{(4\pi R^3) E}{E} \quad [\text{i. e from equation (7)}]$$

$$\Rightarrow \text{Electronic Polarisability} \quad \alpha_e = 4\pi\epsilon_0 R^3$$

Where R= radius of an atom.

Ionic Polarization

Ionic polarization takes place in ionic dielectrics due to displacement of positive and negative ions by the influence of external electric field.

Expression for Ionic Polarisability

When an electric field is applied on an ionic dielectric then positive ions move in the field direction & negative ions move in opposite direction, hence dipoles will be formed. This phenomenon is known as ionic polarization.

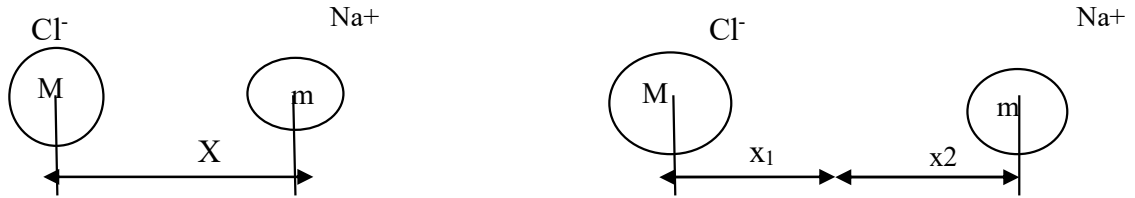

Fig. (a) In the absence of field

Fig. (b) when field is applied

Let 'e' the charge of ions and M and m be the masses of negative and positive ions respectively. When an electric field 'E' is applied on an ionic dielectric then positive ions displace in the field direction through x_1 distance and negative ion displaces in opposite direction through x_2 distance.

The induced dipole moment

$$\mu = | \text{charge} | \times \text{displacement}$$

$$\mu = | e | (x_1 + x_2) \quad \rightarrow (1)$$

But against to the displacement of positive and negative ions, restoring force acts and opposes the displacements of cation and anion.

Under equilibrium conditions, the restoring force

$$F = k_1 x_1 \quad [\text{for negative ion}]$$

$$F = k_2 x_2 \quad [\text{for positive ion}]$$

$$\Rightarrow x_1 = \frac{F}{k_1}$$

$$x_2 = \frac{F}{k_2} \quad \rightarrow (2)$$

where k_1, k_2 are force constants

But

$$\left. \begin{aligned} k_1 &= M\omega_0^2 \\ k_2 &= m\omega_0^2 \end{aligned} \right\} \rightarrow (3)$$

where ω_0 = angular velocity of the ions

Substituting (3) in (2) we get

$$\text{Hence } x_1 = \frac{F}{M\omega_0^2} \text{ \& } x_2 = \frac{F}{m\omega_0^2}$$

But $F = eE$

$$\Rightarrow x_1 = \frac{eE}{M\omega_0^2}$$

$$x_2 = \frac{eE}{m\omega_0^2} \quad \rightarrow (4)$$

Substituting equation (4) in equation (1)

\Rightarrow Electric dipole moment

$$\mu = e[x_1 + x_2]$$

$$\mu = e \left[\frac{eE}{M\omega_0^2} + \frac{eE}{m\omega_0^2} \right]$$

$$\mu = \frac{e^2 E}{m\omega_0^2} \left[\frac{1}{M} + \frac{1}{m} \right] \quad \rightarrow (5)$$

We know that the Ionic Polarizability

$$\alpha_i = \frac{\text{dipole moment}}{\text{electric field}} = \frac{\mu}{E}$$

$$\alpha_i = \frac{\frac{e^2 E \left[\frac{1}{M} + \frac{1}{m} \right]}{\omega_0^2}}{E}$$

$$\alpha_i = \frac{e^2}{\omega_0^2} \left[\frac{1}{M} + \frac{1}{m} \right]$$

Here ω_0 = natural frequency of the ionic molecule.

Orientalional Polarization

Definition:

When Electric field is applied on a polar dielectric then all the dipoles tend to rotate In the field direction, hence dipole moment increases gradually. This phenomenon is known as dipolar (or) orientational polarization.

Expression for Orientalional (or) dipolar Polarisability

Orientation Polarisatation takes place only in polar dielectrics in which dipoles orient in random manner such that the net dipole moment is zero. When Electric field is applied, all the dipoles try to rotate in the field direction as shown in the figure 5.10.

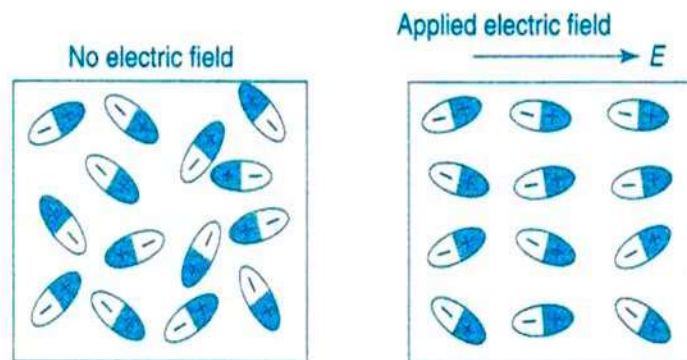

Fig.: Orientalional polarization

To derive an expression for dipolar Polarisability of a system, we have to know the total dipole moment and total number of dipoles present in the system since

$$\text{Average dipole moment } \mu = \frac{\text{Total dipole moment}}{\text{Total number of dipoles}} \rightarrow (1)$$

According to statistical mechanics, the Average component of dipole moment along the field direction is equal to $\mu \langle \cos\theta \rangle$. It is given by

$$\Rightarrow \mu \langle \cos\theta \rangle = \frac{\int_{\theta=0}^{\pi} (\mu \cos\theta) \sin\theta d\theta e^{-\frac{\mu E \cos\theta}{K_B T}}}{\int_0^{\pi} \sin\theta d\theta e^{-\frac{\mu E \cos\theta}{K_B T}}} \rightarrow (2)$$

To evaluate the integral

$$\text{Let } \frac{\mu E}{K_B T} = a$$

$$\text{Let } \frac{\mu E}{K_B T} \cos\theta = x$$

$$a \cos\theta = x$$

$$-a \sin\theta d\theta = dx$$

Then equation (2) becomes & the limits changes from $-a$ to $+a$

$$\mu \langle \cos\theta \rangle = \frac{\mu \int_{-a}^{+a} \left(\frac{x}{a}\right) \left(\frac{-dx}{a}\right) e^x}{\int_{-a}^{+a} \left(\frac{-dx}{a}\right) e^x}$$

$$\langle \cos\theta \rangle = \frac{1}{a} \frac{\int_{-a}^{+a} x e^x dx}{\int_{-a}^{+a} e^x dx} = \left[\frac{e^a + e^{-a}}{e^a + e^{-a}} - \frac{1}{a} \right] = L(a)$$

$$\langle \cos\theta \rangle = L(a) \quad \rightarrow (3)$$

$$\text{(or) } \mu \langle \cos\theta \rangle = \mu L(a)$$

The function $L(a)$ is called the Langevin function

A graph $L(a)$ has been plotted as a function of $a = \frac{\mu E}{K_B T}$ [i.e $a=1$]

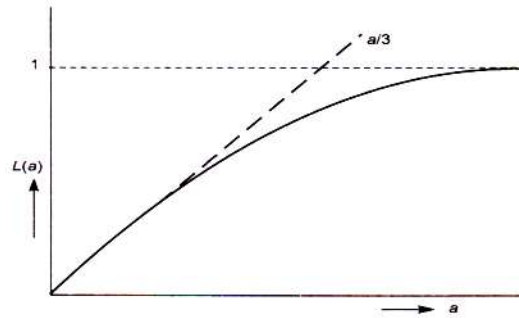

Fig. Langevin curve

From graph for very large values of 'a', i.e for very high field strength, the function approaches the saturation value unity.

This saturation corresponds to complete alignment of dipoles in the field direction, so

That $\langle \cos\theta \rangle = 1$

Hence $\mu \langle \cos\theta \rangle = \mu$

Case i:

But if the field strength is not too high and temperature is not too low, then $a \ll 1$

$$\Rightarrow \frac{\mu E}{K_B T} \ll 1$$

[Also $\mu E \ll K_B T$]

Under these conditions the large in function reaches to: $L(a) = \frac{a}{3}$

From equation (3)

Hence $\mu \langle \cos\theta \rangle = \mu L(a)$ [i.e from equation (3)]

$$\mu \langle \cos\theta \rangle = \mu \left(\frac{a}{3} \right)$$

$$= \frac{\mu}{3} \left[\frac{\mu E}{K_B T} \right] \quad [\text{i.e } a = \frac{\mu E}{K_B T}]$$

$$\mu \langle \cos\theta \rangle = \frac{\mu^2 E}{3 K_B T} \quad \rightarrow (4)$$

But from definition Polarisability i.e orientational (or) dipolar polarisability

$$\alpha_0 \text{ (or) } \alpha_d = \frac{\mu}{E} \text{ (or) } \frac{\mu \langle \cos\theta \rangle}{E}$$

$$\text{(or) } \mu \langle \cos\theta \rangle = \alpha_0 E \quad \rightarrow (5)$$

Equating equations (4) & (5)

$$\alpha_0 E = \frac{\mu^2}{3 K_B T} E$$

$$\alpha_d = \alpha_0 = \frac{\mu^2}{3K_B T}$$

α_0 = Orientational (or) dipolar polarisability

μ = dipole moment

K_B = Boltzmann constant

T = absolute temperature.

Note:

The total polarizability, $\alpha = \alpha_e + \alpha_i + \alpha_0$

$$\alpha = \{4\pi\epsilon_0 R^3\} + \left\{ \frac{e^2}{\omega_0^2} \left[\frac{1}{M} + \frac{1}{M} \right] \right\} + \left\{ \frac{\mu^2}{3K_B T} \right\}$$

Ferro Electricity

Ferro Electric Materials & Applications:

Definition:

Some materials (below a certain temperature) possess spontaneous polarization even when electric field is not applied. These materials have acquired electric dipole moment even no field is applied. These materials are known as Ferro electrics. And this phenomena is known as Ferro electricity.

Ferro Electric Materials

There are 3 main types of crystal structure in Ferro electric materials. They are

(1) Rochelle salt structure also called as Sodium Potassium Tartrate i.e $\{NaK(C_4H_4O_6).4H_2O\}$

(2) The perovskite group consisting of Titanates & Niobates

Eg:- Barium Titanate i.e $\{BaTiO_3\}$

(3) The dihydrogen Phosphates & Arsenates

Eg:- $\{KH_2PO_4\}$

Some other examples of ferro electric materials are:

Ammonium dihydrogen phosphate ($NH_4H_2PO_4$)

Lithium Niobate ($LiNbO_3$)

Potassium Niobate ($KNbO_3$) etc

Properties of Ferro electric materials

- The Ferro electric materials possess' spontaneous polarization below a certain temperature.
- As temperature increases the spontaneous polarization decreases and at a particular temp, the spontaneous polarization vanishes. This temperature is called Curie temperature. It is defined as the temperature at which Ferro electric material converts into a Para electric material.

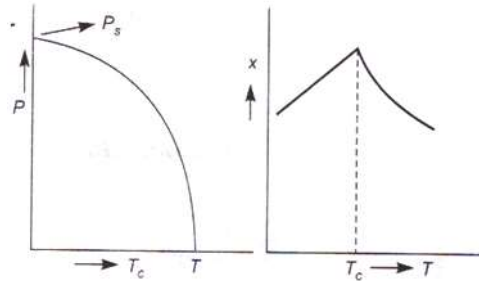

Fig. (a) Spontaneous polarization with respect to temperature (b) Variation of ϵ_r or χ with respect to temperature

- Below T_c - curie temperature; the dielectric material possesses Ferro electric property. As temperature increases the dielectric constant reduces after ' T_c '. It is shown in the figure 5.13

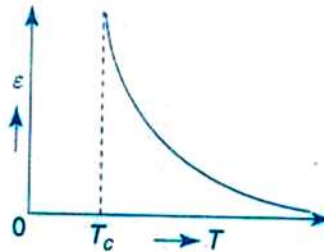

Fig. Variation of dielectric constant with temperature

From curie-Weiss law $\epsilon_r = \frac{C}{T - T_c}$

ϵ_r = Dielectric constant, C = curie constant,

T = absolute temperature, T_c = curie temperature

- The Ferro electrics exhibit the property called Piezo–electricity & Pyroelectricity.
- “Piezo electricity” means when mechanical stress is applied to Ferro electric materials then the opposite charges are formed on the surface of crystal generating electricity. [In greek ‘piezo’ means pressure]
- “Pyro electricity” means the change of Spontaneous Polarisation of Ferro electric materials by the application of temperature. [In Greek “Pyro means Heat]
- Ferro electric materials also exhibit the property called “Di-electric Hysteresis”
- Dielectric Hysteresis: It is defined as the lagging of polarization behind the electric field applied. The area of the loop represents the dielectric loss.

Applications of Ferro Electric Materials

- The Ferro electrics have high dielectric constant ϵ_r . They are used in small sized capacitors to produce large capacitance.
- As they satisfy Dielectric Hysteresis property; they can be used as memory devices in computers.
- Piezo-electric transducers are used to produce & to detect sound waves.

- Pyro electric behavior in Ferro electrics is used to detect infrared radiation.
- They are used in electro mechanical filters.

Dielectric Hysteresis

Definition: It is a property of lagging of polarization behind the applied electric field. The area of the loop represents the dielectric loss in the dielectric Ferro electric materials.

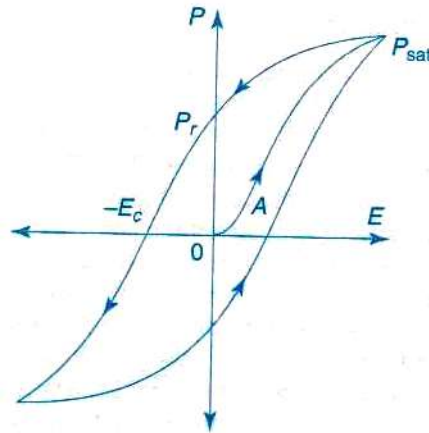

Fig. Dielectric Hysteresis (Variation of polarization with electric field)

Explanation:

- When electric field 'E' is applied the polarization rapidly increases and reaches a point called saturation polarization which is constant.
- If electric field is made zero [E=0] the polarization will not reach the original point 'O'. But takes a new path at point 'P_r' known as Remanent (or) remained polarization.
- To destroy 'P_r' a negative electric field is applied, hence P_r=0
- The field required to make P_r=0 is known as negative coercive electric field i.e '-E_c'.
- Further if 'E' is increased, negative polarization takes place and reaches to '-P_s' known as negative saturation polarization.
- If negative electric field (-E) is decreased back to zero, the negative saturation (-P_s) will not go to the point 'O' but creates a new path at point '-P_r'. This is known as negative remanent polarization.
- To destroy this '-P_r' a positive electric field is applied. This field 'E_c' is positive coercive field.
- At last increase of electric field leads to reach again, positive saturation polarization. This is a cyclic process.
- In the above mechanism the polarization started at point 'O' does not reach back to that point. Hence polarization lags behind the electric field applied which is known as "Dielectric Hysteresis".

Structure of BaTiO_3 - A Ferro electric material

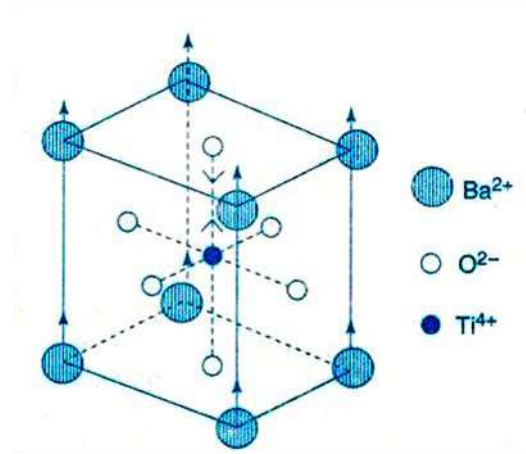

Fig. Structure of BaTiO_3 above T_c

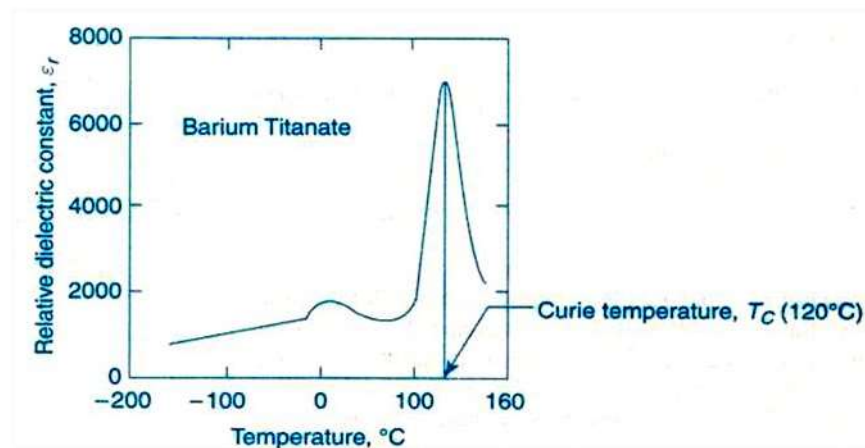

Fig. Variation of dielectric constant with temperature

- We know that BaTiO_3 is a ferro electric material. The cubic unit cell of BaTiO_3 crystal structure consists of Barium cations at the corners & oxygen anions at the face centers. Titanium ion is in the octahedral void at the body center.
- Above 120°C , BaTiO_3 is a cubic crystal. In this state, the centers of positive and negative charges coincide. Hence there is no spontaneous dipole moment & polarization is zero.
- If the crystal is cooled below 120°C , the titanium ions shift to one side of the body centre and neighboring oxygen ions are also get shifted. The centers of positive charge due to titanium cations and centers of negative charges due to oxygen anions gets shifted (o) displaced. Hence dipoles are created to give dipole moment.

5.11 Piezo Electricity (or) Piezo electric effect

The development of electrical charges and electric polarization when subjected to stress is called “Piezo electric effect”. This phenomenon was discovered by “Curie Brothers in 1880”.

- Crystals like quartz, Tourmaline, Rochelle salt when subjected to compression or tension then opposite charges develop on their surfaces.

- The materials also exhibit “Inverse Piezo Electric Effect”. That is on these substances when electric field is applied, they get strained. That means the dimensions gets changed. The crystals either expand (or) contract.
- Quartz also undergo vibrations.
- All Ferro electric are Piezo electric. But all Piezo electric materials need not necessarily be Ferro electric.
Example:- Barium Titanate exhibits both Ferro electricity and Piezo electricity.
- Quartz is only Piezo electric.

Piezo electricity in quartz crystal

Quartz is silicon dioxide (SiO₂). The atoms are arranged in the form of Hexagon. The quartz consists of three axes: X-axis known as Electrical axis, Y-axis known as Mechanical axis & Z- axis known as Optical axis. When external stress is not applied, all the charges get balanced. Hence net polarization is zero. When external stress is applied, the balance is disturbed. Hence crystal is polarized. As a result, electrical charge is developed on the faces. The structure of quartz is shown in the figure below.

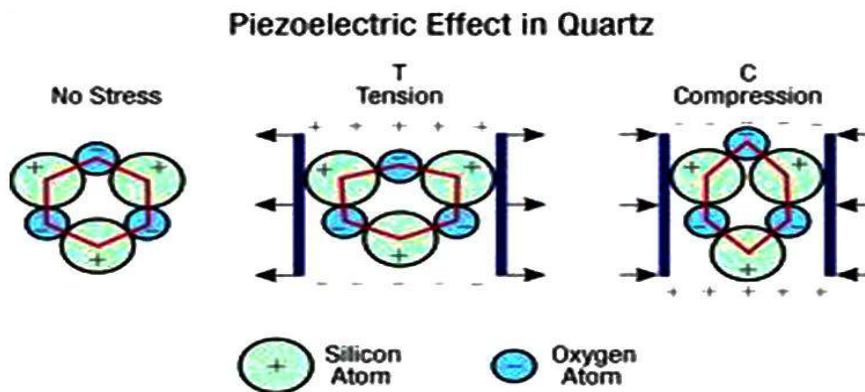

Fig. Piezo electric effect in quartz crystal

Applications of Piezo electric materials

- In case of Inverse Piezo electric effect, If a quartz plate is subjected to an alternating electric field, the quartz crystal expands or contracts. This also undergoes vibrations. If the frequency of vibration of quartz crystal is equal to ultrasonic frequency, then the ultrasonic waves are produced. Hence quartz oscillator is used to produce ultrasonic waves.
- Rochelle salt- a dielectric material is used in gramophones, ear phones, hearing aids, microphones etc.
- Barium titanate, lead zirconate, lead titanate is used for high voltage generation.
- A transducer is a device which converts one form of energy into another. Piezo electric effect can be utilized to convert force, pressure and strain into electrical voltages.
- Acceleration transducers are used to measure acceleration.
- Piezo electric crystals are used to produce radio frequency waves for broad casting.

- They are used in quartz watches to maintain accurate time.

Pyro Electricity

Definition: Pyro electric effect is the change in spontaneous polarization when the temperature of the specimen is changed.

Explanation

- Many Piezo-electric materials, such as tourmaline, have the tendency to exhibit a change in internal electrical polarization as a response to temperature changes.
- An electric field develops in a pyro-electric crystal as a result of temperature change.
- Pyro-electricity requires the presence of permanent electric dipoles (whose magnitude is affected as a result of temperature changes).
- It is possible to detect a change of 10^{-16} coulomb with a suitable electrometer, temperature changes as small as 10^{-6} °C can be measured using the pyro electric effect.

Applications

- The Pyro- electric materials such as BaTiO₃, LiNbO₃ etc are used to make very good Infra-red detectors which can operate at room temperature.
- Materials such as TGS, NaNO₂ and PZT ceramics are used in the construction of pyroelectric image tubes.
- Used in burglar alarms, which detect the thermal radiation from Human body.

MAGNETIC PROPERTIES

Introduction

- The magnetic effects in magnetic materials are due to atomic magnetic dipoles in the materials. These dipoles result from effective current loops of electrons in atomic orbits, from effects of electron spin & from the magnetic moments of atomic nuclei.
- The electric currents in an atom are caused by orbital and spin motions of electrons and those of its nucleus. Since all these motions of charged particles form closed electric currents, they are equivalent to “magnetic dipoles”. When such dipoles are subjected to an external electric field, they experience a torque which tends to align their magnetic moments in the direction of the externally applied field.

Definitions

Magnetic dipole

Each tiny dimension of a magnetic material (or) atoms in magnetic materials is called magnetic dipole. This magnetic dipole produces magnetic moment depending on the

alignment with respect to the applied magnetic field.

Magnetic flux (Φ)

It is defined as the amount of magnetic lines of forces passing perpendicularly through unit area of a given material. It is denoted by ' Φ '

$$\Phi = AB$$

Where A = Area of cross section of the material in m^2
 B = magnetic Induction in Wb/m^2

Units: Weber (Wb)

Intensity of Magnetization (M)

When a material is magnetized, it develops a net magnetic moment. The magnetic moment per unit volume is called Intensity of magnetization

$$\text{Magnetization (M)} = \frac{\text{Magnetic moment}}{\text{Volume}}$$

Units: Amp/m

Magnetic Induction (B)

Magnetic induction at a point is defined as the force experienced by a unit North Pole Placed at that point. It is denoted by ' B '

$$\text{i.e. } B = \frac{\Phi}{A} \text{ weber / m}^2$$

Magnetizing field strength (H)

When a medium is exposed to a magnetic field of intensity ' H ', it causes an induction ' B ' in the medium.

$$\text{i.e. } B \propto H$$
$$B = \mu H$$

Where μ = absolute permeability of the medium.

If the medium is air or vacuum

$$B = \mu_0 H$$

μ_0 = permeability of free space i.e. air or vacuum

$$\mu_0 = 4\pi \times 10^{-7} \text{ H/m}$$

Units for H: Amp /m.

Permeability (μ)

It indicates, with which the material allows magnetic lines of force to pass through it.

Or

It is the ability of the medium to pass magnetic lines of forces through it.

There are three Permeabilities i.e. μ_1 , μ_0 , μ_r

$$\mu = \mu_0 \mu_r$$

Where μ = Absolute permeability of the medium

μ_0 = Permeability of free space i.e. air or vacuum

μ_r = Relative permeability of the medium

Magnetic moment

Magnetic moment $\mu_m = (\text{current}) \times (\text{area of circulating orbit})$

$$\mu_m = (I) \times (\pi r^2)$$

Units: Amp-m²

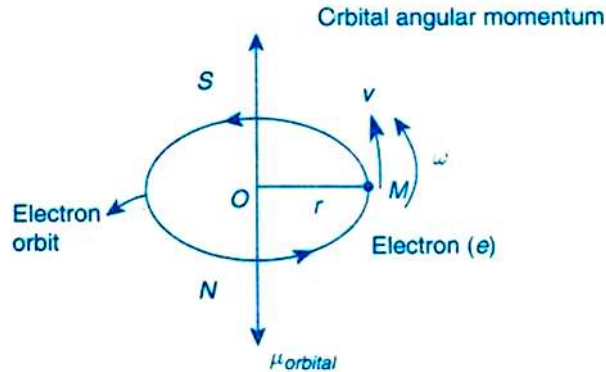

Fig. Revolving electron in an atom produces magnetic moment

When the magnetic dipoles (atoms consisting of charged particles like protons & neutrons) undergo orbital motion (or) spin motion produces a magnetic moment. Since motion of charged particles is considered as closed electric current loops which in turn produces a magnetic moment.

Relation between B, H, M

We know that

$$B = \mu H \quad \rightarrow (1)$$

But

$$\mu = \mu_0 \mu_r$$

$$B = \mu_0 \mu_r H$$

$\rightarrow (2)$

Adding & subtracting with $\mu_0 H$ on right hand side of equation (2)

$$B = [\mu_0 \mu_r H] + \mu_0 H - \mu_0 H$$

$$= [\mu_0 \mu_r H - \mu_0 H] + \mu_0 H$$

$$= \mu_0 H [\mu_r - 1] + \mu_0 H$$

But

$$M = H [\mu_r - 1] \quad \rightarrow (3)$$

Now eq(3) becomes

$$B = \mu_0 M + \mu_0 H$$

$$B = \mu_0 [H + M]$$

$\rightarrow (4)$

Consider equation (3),

$$M = H [\mu_r - 1]$$

$$\frac{M}{H} = \mu_r - 1$$

$\rightarrow (5)$

But magnetic susceptibility

$$\chi = \frac{M}{H}$$

From equations (5) and (6)

$$\chi = \frac{M}{H} = \mu_r - 1$$

$$\mu_r = 1 + \chi$$

Magnetic susceptibility (χ)

If H is the applied magnetizing field intensity and M is the amount of magnetization of the material, Then χ

$$= \frac{M}{H}$$

$\chi = 0$ in vacuum

$\chi = +ve$ for paramagnetic and Ferro magnetic materials

$\chi = -ve$ for diamagnetic materials

Units: It has no units.

Origin of magnetic moment (Or) Sources of magnetic moment

In atoms, the permanent magnetic moment arises due to

- Orbital motion of electrons and its magnetic moment is called orbit magnetic moment of electrons (μ_l)
- The spin of electrons and its magnetic moment is called spin magnetic moment of electrons (μ_s)
- The spin of nucleus (due to protons) and its magnetic moment is called spin magnetic moment of the nucleus. (μ_n or μ_p).

Explanation

a) Magnetic moment due to orbital motion of the electrons (μ_l)

Let us consider an electron of charge 'e' revolving around a nucleus in time period 'T' in a circular orbit of radius 'r'. Then a magnitude of circular current 'I' is given by

$$I = \frac{\text{Charge}}{\text{Time}} = \frac{e}{T} \quad \rightarrow (1)$$

But $T = \frac{2\pi}{\omega}$

Where ω = angular velocity of electron

$$I = \frac{e\omega}{2\pi}$$

But magnetic moment of electron is $\mu_l = I \times A$

μ_l = current area of circulating orbit

$$\mu_l = \frac{e\omega}{2\pi} (\pi r^2)$$

$$\mu_l = \frac{e\omega r^2}{2} \quad \rightarrow (2)$$

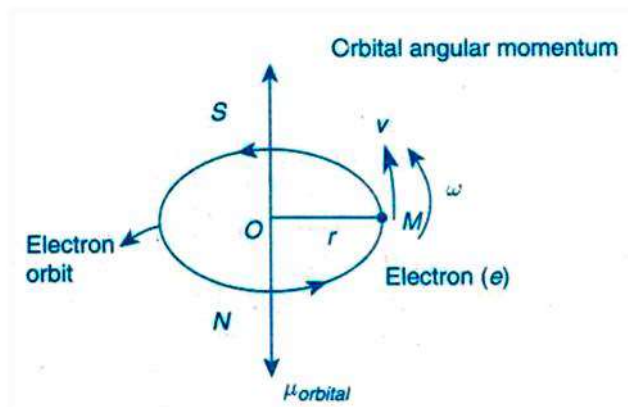

Fig. Orbital magnetic moment of electrons

We know that angular momentum of any particle, $L = m\omega r^2$

Substituting eq.(4) in eq.(3) we get

Orbital magnetic moment, $\mu_l = \left(-\frac{e}{2m}\right) \cdot L$ → (5)

[-ve sign indicates μ_l and L are in opposite directions]

$$\mu_l = \left(-\frac{e}{2m}\right) L$$

But from Bohr's atomic model

$$mvr = \frac{nh}{2\pi}$$

$$L = \frac{lh}{2\pi} \quad \text{Where } l = \text{orbital quantum number}$$

L = orbital angular momentum

The values of $l = 0, 1, 2, \dots, (n-1)$

$$\text{Hence } \mu_l = \left(-\frac{e}{2m}\right) \left(\frac{lh}{2\pi}\right)$$

$$\mu_l = -\left(\frac{eh}{4\pi m}\right) l \quad \rightarrow (6)$$

Where $\frac{eh}{4\pi m} = \mu_B$ is a constant called Bohr magneton and its value is $9.27 \times 10^{-24} \text{ amp}\cdot\text{m}^2$

Hence eq(6) becomes

$$\mu_l = l \mu_B \quad \rightarrow (7)$$

Bohr magneton is the fundamental unit of magnetic moment.

It is clear from eq (7) that electron can take only certain specified values of magnetic moment depending on the value of 'l'.

Bohr suggested that both magnitude and direction of 'l' are quantified. It is known as "Spatial quantization".

The spatial quantization introduces a new set of quantum numbers.

(a) Orbital magnetic quantum number (m_l)

(b) Spin magnetic quantum number (m_s)

For example: If electron is in 'p' shell. Then $n = 2, L = 0$ to $n-1, L = 0, 1,$

If electron is placed in external magnetic field then eqn (6) can be written as

$$-\left(\frac{eh}{4\pi m}\right) m_l \quad \rightarrow (8)$$

Hence for 'p' shell electron, $m_l = 0$ to $\pm L$. The values are $m_l = -1, 0, 1$

Hence eqn (8) becomes

$$-\left(\frac{eh}{4\pi m}\right), 0, \left(\frac{eh}{4\pi m}\right)$$

Therefore we have "Three" possible orientations for electron in d-shell which is shown in the figure 6.3.

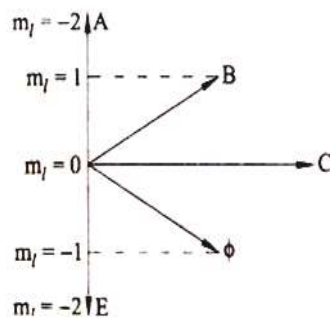

Fig. The three possible orientations of electron

- ‘OC’ represents the orientation of electron if $m_l = 0$
- ‘OB’ represents the orientation of electron if $m_l = +1$
- ‘OD’ represents the orientation of electron if $m_l = -1$

b) Magnetic moment of electrons due to spin of electrons (μ_s)

According to quantum theory; electrons should have intrinsic angular momentum due to spin. Spin is also quantized both in magnitude and direction spin can take only one value i.e $\frac{1}{2}$ or $-\frac{1}{2}$. The magnetic moment produced due to spin of electrons is called spin magnetic moment (μ_s).

It is given by

$$\text{Spin magnetic moment } \mu_s = -2\left(\frac{e}{2m}\right) S \quad \rightarrow (9)$$

Where S=spin angular momentum, e = charge of electron, m = mass of electron

$$S = \frac{sh}{2\pi}$$

where S = spin quantum number

h = Planck’s constant.

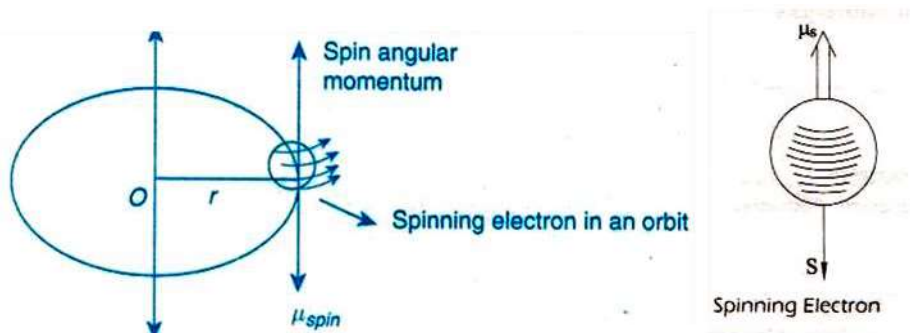

Fig. Spin magnetic moment of electrons

From equation (9),

$$\mu_s = -2\left(\frac{e}{2m}\right) S$$

Since $S = \frac{sh}{2\pi}$

$$\mu_s = -2\left(\frac{e}{2m}\right) \left(\frac{sh}{2\pi}\right)$$

$$s = \pm \frac{1}{2}, \quad \mu_s = \pm \frac{eh}{4\pi m}$$

$$\mu_s = \frac{eh}{4\pi m}, \quad -\frac{eh}{4\pi m}$$

$$\mu_s = + \mu_B, - \mu_B$$

Hence spin magnetic moment of electron is equal to μ_B . That is one Bohr magneton

Hence there are two possible orientations of electron.

Conclusion: Para magnetism, Ferro magnetism is due to spin magnetic moment.

Diamagnetism is due to orbital magnetic moment.

(c) Magnetic moment due to Nuclear spin or spin of all protons (μ_n)

The magnetic moment of the nucleus is given by $\mu_n = \frac{eh}{4\pi m_p}$ $\rightarrow (10)$

Where m_p = mass of proton

The constant $\frac{eh}{4\pi m_p}$ is called nuclear magneton.

The value of nuclear magneton $\frac{eh}{4\pi m_p} = 5 \times 10^{-27} \text{ A}\cdot\text{m}^2$

This is small when compared to Bohr magneton.

Classification of Magnetic Materials

Magnetic materials are classified as follows:

- a) Diamagnetic
- b) Paramagnetic
- c) Ferro magnetic
- d) Anti Ferro magnetic
- e) Ferric magnetic or ferrites

Diamagnetic materials	Paramagnetic materials	Ferromagnetic materials	Anti ferro magnetic materials	Ferrimagnetic materials (ferrites)
<p><i>Diamagnetism:</i> It is the property of the material which has repulsive nature (or) opposing magnetization</p>	<p><i>Paramagnetism:</i> It is the property of the material which has weak attractive force.</p>	<p><i>Ferromagnetism</i> is property of the material which has strong attractive force.</p>	<p><i>Anti Ferro magnetism:</i> is the property of the material which has weak attractive force.</p>	<p><i>Ferrimagnetism:</i> It is the property of the material which has strong attractive force.</p>
<p>2.The property is due to orbital motion of electrons</p>	<p>2.The property is due to spin of electrons</p>	<p>2.The property is due to spin of electrons</p>	<p>2. The property is due to spin of electrons.</p>	<p>2.The property is due to spin of electrons</p>

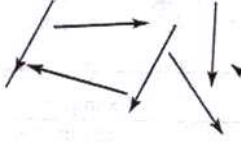
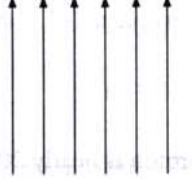
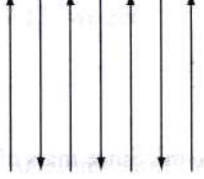
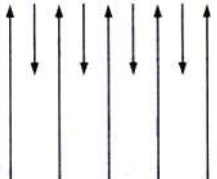
<p>3. There is no spin</p>	<p>3. Spin is random</p> 	<p>3. Spin is parallel</p> 	<p>3. Spin is anti parallel.</p> 	<p>3. Spin is anti parallel but of different magnitudes.</p> 
<p>4. These materials are lack of magnetic dipoles</p>	<p>4. These materials have permanent dipoles</p>	<p>4. They have permanent magnetic dipoles</p>	<p>4. They have permanent magnetic dipoles</p>	<p>4. They have permanent magnetic dipoles.</p>
<p>5. They do not possess permanent dipole magnetic moment (it is zero). Hence spontaneous magnetization is zero.</p>	<p>5. They possess permanent magnetic dipole moment. But there is no spontaneous magnetization in the absence of external field. Due to random spin.</p>	<p>5. They possess permanent magnetic dipole moment. Also in the absence of field they have spontaneous magnetization even in the absence of external field due to parallel</p>	<p>5. They do not possess permanent magnetic dipole moment. Since in the absence of field they have no spontaneous magnetization due to anti parallel spin</p>	<p>5. They possess permanent magnetic dipole moment. Also in the absence of field they have spontaneous magnetization. Since spin is anti parallel but of different magnitudes.</p>
<p>6.</p>	<p>6.</p>	<p>6.</p>	<p>6.</p>	<p>6.</p>

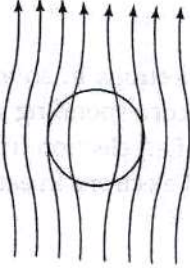
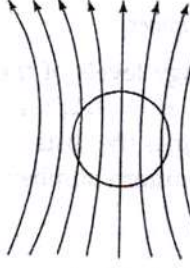
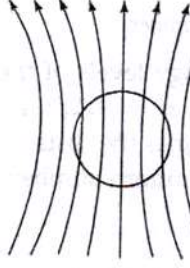
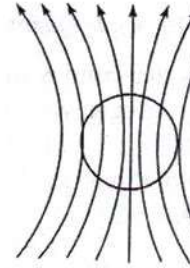
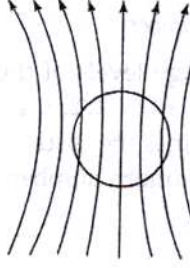
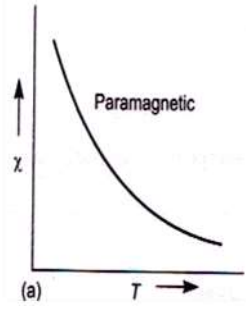
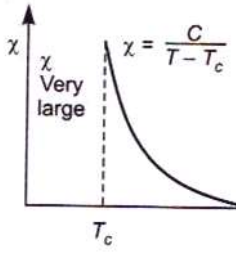
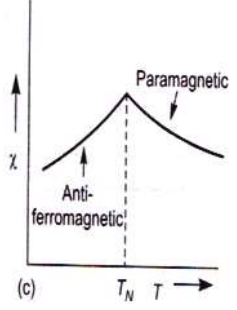
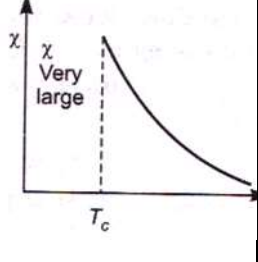
 <p style="text-align: center;">$B_{in} < B_{out}$</p>	 <p style="text-align: center;">$B_{in} > B_{out}$</p>	 <p style="text-align: center;">$B_{in} > B_{out}$</p>	 <p style="text-align: center;">$B_{in} \gg B_{out}$</p>	 <p style="text-align: center;">$B_{in} > B_{out}$</p>
7. The relative permeability $\mu_r < 1$	7. The relative permeability $\mu_r > 1$.	7. The relative permeability $\mu_r \gg 1$	7. The relative permeability $\mu_r > 1$	7. The relative permeability $\mu_r \gg 1$
8. Susceptibility χ is small and negative	8. Susceptibility is small but positive	8. Susceptibility is large and positive	8. Susceptibility χ is small but negative	8. Susceptibility is large and positive
9. χ does not depend on temperature. No particular graph is drawn.	9. χ depends on temperature 	9. χ depends on temperature 	9. χ depends on temperature 	9. χ depend on temperature 
10. χ does not depend on temperature	10. $\chi = c/T$ (curie law) C=curie constant T = absolute temperature	10. $\chi = c/T - \theta$ curie-Weiss law θ = curie temperature	10. $\chi = C/T + \theta = C/T + T_N$ T_N = Neel temperature	10. $\chi = C/T \pm T_N$ T = absolute temperature
11. Examples	11. Examples:	11. Examples:	11. Examples	11. Examples

Cu, Au, Zn, H ₂ O, Bi etc. organic materials.	Al, Pt, Mn, CuCl ₂ etc. Alkali & transition metals.	Fe, Ni, Co, MnO, Fe ₂ O ₃ , Zn ferrite, Ni ferrite, Mn ferrite	FeO, MnO, Cr ₂ O ₅ etc.	ZnFe ₂ O ₄ , Ni ferrite, Cu ferrite, Mn ferrite, Ferrous Ferrite
--	--	--	---	--

Domain theory (or) Weiss theory of Ferromagnetism

- According to Weiss, Ferromagnetic material consists of a number of regions called “Domains” [$\sim 10^{-6}$ mts] which are spontaneously magnetized.

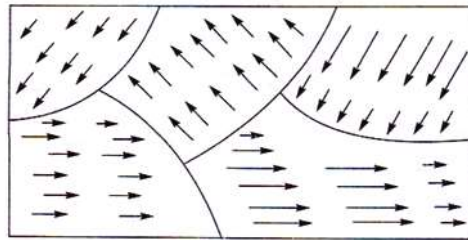

Fig. : Different possible orientations of domains

- Spontaneous magnetization is due to parallel alignment of all magnetic dipoles (in each domain) even when no external field is applied.
- Different domains possess different orientations hence net magnetization is zero.
- When an external field is applied there are two possible ways of alignment of domains. They are
 - By motion of domain walls
 - By rotation of domain walls
- Domains arise to minimize the energy of the material. The total internal energy is minimum. The alignment of domains, parallel to field is discussed as follows:
 - The domains which are parallel to the direction of applied magnetic field will grow in size than other domains. This is called “Motion of domain walls”. Also other domains which are opposite to the field direction are reduced. This is shown in the figure 6.6.

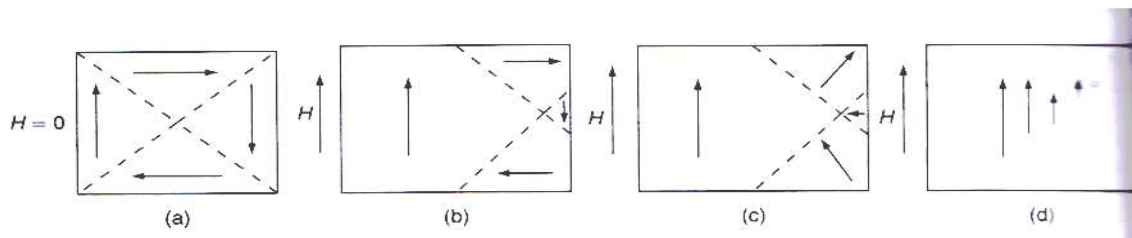

Fig. 6.6 (a) Domain orientation in the absence of the magnetic field (b) Domain enhancement & shrinkage due to weak fields (c) Domain rotation due to strong fields (d) Saturation due to very high fields

- As the magnetic field is strong, the magnetic moments of the domains can rotate in the applied field direction. This is called “rotation of domain walls”.

Domain theory of ferromagnetism based on the basis of B-H curve

(or) Hysteresis curve

Definition: Hysteresis means the lagging of magnetization “B” behind the applied magnetizing field “H”. The energy supplied to the specimen during magnetization is not fully used. The balance of energy left in the material is produced as heat i.e. loss of heat called” Hysteresis Loss”.

- This phenomenon of magnetic Hysteresis is an “Irreversible” characteristic of ferromagnetic material. The loop (or) area refers to the hysteresis loop. Hysteresis loss occurs in ferromagnetic materials below Curie temperature.

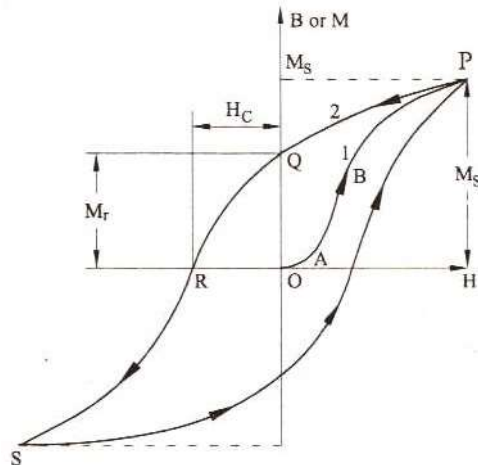

Fig. : Magnetic Hysteresis curve (or) B – H curves of a Ferro magnetic material

The complete cycle of operation is discussed as follows:

- When the magnetic field is applied on a ferromagnetic material the magnetization increases slowly and reaches a constant M_s called saturation magnetization
- In fig (6.7) from point O to A, the displacement of domain walls takes place. When the field is suddenly off, the domains again go for original position.
- From point A to B, as the field is further increased, the magnetization also increases. Here when the field is made off the domain displacement does not return back to original condition.
- For higher fields the magnetization reaches maximum ie saturation magnetization M_s due to rotation of domain walls.
- In this case at the region B to P, if the field is suddenly made off, the domains does not return back to original direction. But there is some magnetic field remained inside the specimen.
- The point M_s is called saturation of magnetization. When the field is off, the curve does not go back to ‘O’[as shown in fig] but creates a new path to a point M_r called “retentivity” (or) residual (or) remanence Magnetization
- To reduce the residual magnetism to zero, a negative field ‘ H_c ’ has to be applied. When the sufficient negative field is applied, the residual; magnetization becomes zero and this field is known as “negative coercive field” ($-H_c$) or coercively. Further again if the negative field is applied then magnetization increases but in negative direction. This is known as negative saturation magnetization ($-M_s$).

- If the negative field is decreased back to zero the negative saturation of magnetization will not reach the initial path at '0' but creates a new path and reaches a point called negative residual magnetism ' $-M_r$ ' known as negative receptivity.
- To decrease the negative residual magnetism to zero some positive field is applied. The amount of magnetic field required to bring residual magnetization to zero is known as positive coercive field (H_c).
- Further the increase of positive magnetic field the magnetization reaches again to positive saturation (M_s) and this is a cyclic process.
- The final conclusion is that when the magnetization vector is started from origin 'O' will not reach back to that point. "The magnetization lags behind H". This is called magnetic hysteresis loss measured in the area of the loop (or) curve. If the loop area of a ferromagnetic material is large, more energy is wasted. This is also called as "dielectric loss" for one complete cyclic operation.

MODULE-V

LASERS AND FIBER OPTICS

Introduction

LASER stands for light amplification by stimulated emission of radiation. It is different from conventional light (such as tube light or electric bulb), there is no coordination among different atoms emitting radiation. Laser is a device that emits light (electromagnetic radiation) through a process is called stimulated emission.

Spontaneous and stimulated emission

In lasers, the interaction between matter and light is of three different types. They are: absorption, spontaneous emission and stimulates emission .Let E_1 and E_2 be ground and excited states of an atom. The dot represents an atom. Transition between these states involves absorption and emission of a photon of energy $E_2-E_1=h\nu_{12}$. Where „h“ is Planck“s constant.

- (a) **Absorption:** As shown in fig8.1(a), if a photon of energy $h\nu_{12}(E_2-E_1)$ collides with an atom present in the ground state of energy E_1 then the atom completely absorbs the incident photon and makes transition to excited state E_2 .
- (b) **Spontaneous emission:** As shown in fig8. 1. (b), an atom initially present in the excited state makes transition voluntarily on its own. Without any aid of external stimulus or an agency to the ground. State and emits a photon of energy $h \nu_{12}(=E_2-E_1)$.this is called spontaneous emission. These are incoherent.
- (c) **Stimulated emission:** As shown in fig8.1.(c), a photon having energy $h\nu_{12}(E_2-E_1)$ impinges on an atom present in the excited state and the atom is stimulated to make transition to the ground state and gives off a photon of energy $h\nu_{12}$. The emitted photon is in phase with the incident photon. These are coherent. This type of emission is known as stimulated emission.

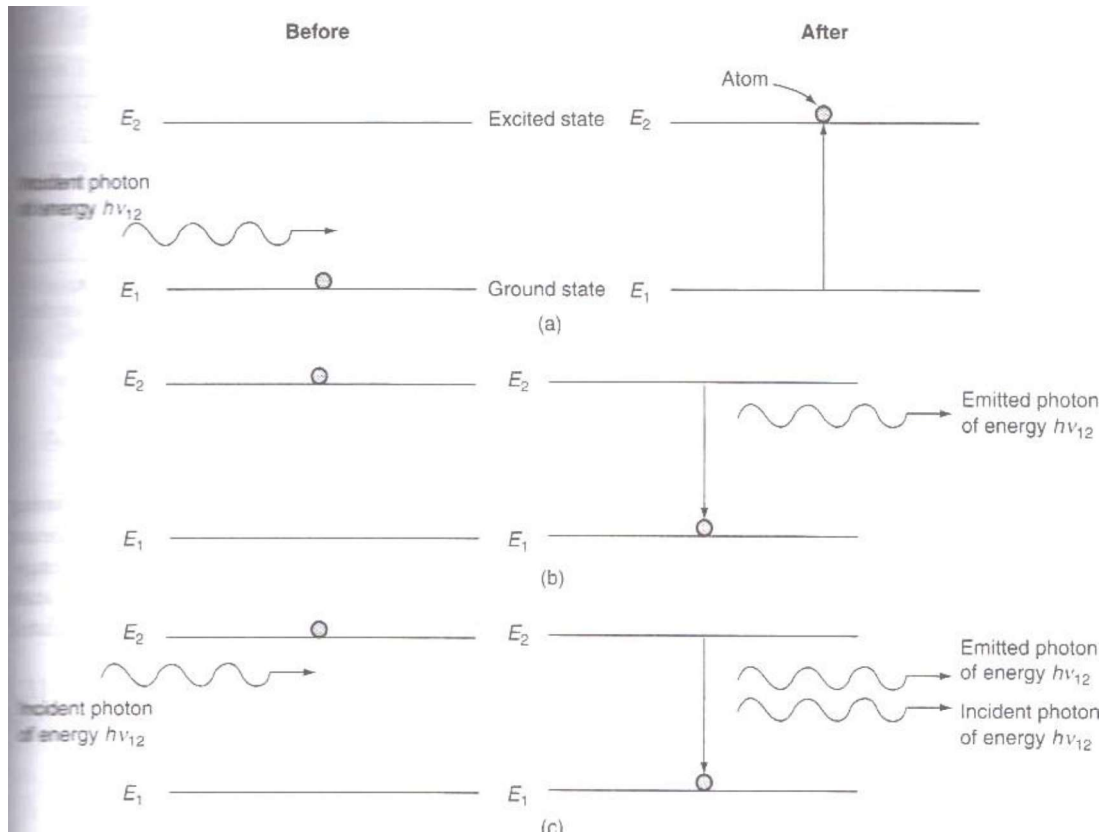

Fig. (a) Absorption ;(b) Spontaneous emission;(c) Stimulated emission

Differences between Spontaneous emission and stimulated emission of radiation

Spontaneous emission	Stimulated emission
1. Polychromatic radiation	1. Monochromatic radiation
2. Less intensity	2. High intensity
3. Less directionality, more angular spread during propagation	3. High directionality, so less angular spread during propagation.
4. Spatially and temporally incoherent radiation	4. Spatially and temporally coherent radiation.
5. Spontaneous emission takes place when excited atoms make a transition to lower energy level voluntarily without any external stimulation.	5. Stimulated emission takes place when a photon of energy equal to $h\nu_{12}$ ($=E_2-E_1$) stimulates an excited atom to make transition to lower energy level.

Characteristics of Laser Light

(i). **Coherence:** Coherence is one of the unique properties of laser light. It arises from the stimulated emission process. Since a common stimulus triggers the emission events which

provide the amplified light, the emitted photons are in step and have a definite phase relation to each other. This coherence is described in terms of temporal and spatial coherence.

(ii). Monochromaticity: A laser beam is more or less in single wave length. I.e. the line width of laser beams is extremely narrow. The wavelengths spread of conventional light sources is usually 1 in 10^6 , where as in case of laser light it will be 1 in 10^5 . I.e. if the frequency of radiation is 10^{15} Hz., then the width of line will be 1 Hz. So, laser radiation is said to be highly monochromatic. The degree of non-monochromaticity has been expressed as

$\xi = (d\lambda/\lambda) = dv/v$, where $d\lambda$ or dv is the variation in wavelength or variation in frequency of radiation.

(iii) Directionality: Laser beam is highly directional because laser emits light only in one direction. It can travel very long distances without divergence. The directionality of a laser beam has been expressed in terms of divergence. Suppose r_1 and r_2 are the radii of laser beam at distances D_1 and D_2 from a laser, and then we have.

Then the divergence, $\Delta\theta = (r_2 - r_1) / (D_2 - D_1)$

The divergence for a laser beam is 0.01 mille radian where as incase of search light it is 0.5 radian.

(iv) High intensity: In a laser beam lot of energy is concentrated in a small region. This concentration of energy exists both spatially and spectrally, hence there is enormous intensity for laser beam. The power range of laser is about 10^{-13} w for gas laser and is about 10^9 w for pulsed solid state laser and the diameter of the laser beam is about 1 mm. then the number of photons coming out from a laser per second per unit area is given by

$$N_1 = P / h\nu\pi r^2 \approx 10^{22} \text{ to } 10^{34} \text{ photons/m}^2\text{-sec}$$

By assuming $h\nu = 10^{-19}$ Joule, Power $P = 10^{-3}$ to 10^9 watt $r = 0.5 \times 10^{-3}$ meter

Based on Planck's black body radiation, the number of photons emitted per second per unit area by a body with temperature T is given by

$$N_{th} = (2h^3C/\lambda^4) (1/e^{h\nu/kT} - 1) d\lambda \approx 10^{16} \text{ photons/m}^2\text{.sec}$$

By assuming $T = 1000\text{k}$, $\lambda = 6000\text{\AA}$

This comparison shows that laser is a highly intensive beam.

Population inversion

Usually in a system the number of atoms (N_1) present in the ground state (E_1) is larger than the number of atoms (N_2) present in the higher energy state. The process of making $N_2 > N_1$ called population inversion. Conditions for population inversion are:

- The system should possess at least a pair of energy levels ($E_2 > E_1$), separated by an energy of equal to the energy of a photon ($h\nu$).
- There should be a continuous supply of energy to the system such that the atoms must be raised continuously to the excited state.

Population inversion can be achieved by a number of ways. Some of them are (i) optical pumping (ii) electrical discharge (iii) inelastic collision of atoms (iv) chemical reaction and (v) direct conversion

Helium-Neon gas laser

Helium-Neon gas laser is a continuous four level gas laser. It consists of a long, narrow cylindrical tube made up of fused quartz. The diameter of the tube will vary from 2 to 8 mm and length will vary from 10 to 100 cm. The tube is filled with helium and neon gases in the ratio of

10:1. The partial pressure of helium gas is 1mm of Hg and neon gas is 0.1mm of Hg so that the pressure of the mixture of gases inside the tube is nearly 1 mm of Hg.

Laser action is due to the neon atoms. Helium is used for selective pumping of neon atoms to upper energy levels. Two electrodes are fixed near the ends of the tube to pass electric discharge through the gas. Two optically plane mirrors are fixed at the two ends of the tube at Brewster angle normal to its axis. One of the mirrors is fully silvered so that nearly 100% reflection takes place and the other is partially silvered so that 1% of the light incident on it will be transmitted. Optical resources column is formed between these mirrors.

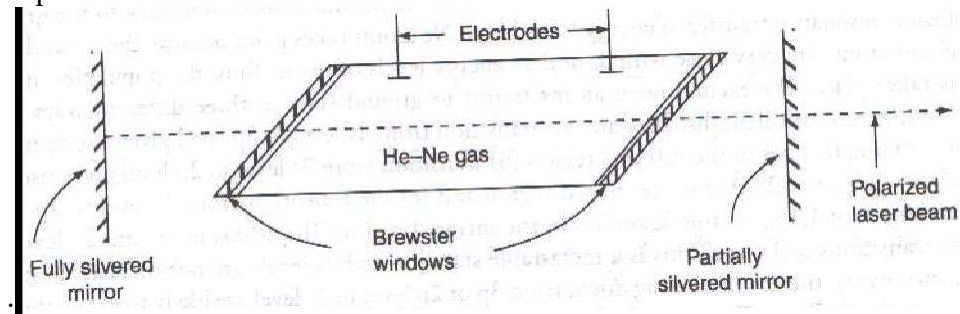

Fig. Helium-Neon gas laser

Working

When a discharge is passed through the gaseous mixture, electrons are accelerated down the tube. These accelerated electrons collide with the helium atoms and excite them to higher energy levels. The different energy levels of Helium atoms and Neon atoms is shown in fig.2.3 the helium atoms are excited to the levels F_2 and F_3 these levels happen to be meta stable energy states.

Energy levels and hence Helium atoms excited levels spend sufficiently large amount of time before getting de excited. As shown in the fig 2.5(a), some of the excited states of neon can correspond approximately to the same energy of excited levels F_2 and F_3 . Thus, when Helium atoms in level F_2 and F_3 collide with Neon atoms in the ground level E_1 , an energy exchange takes place. This results in the excitation of Neon atoms to the levels E_4 and E_6 and de excitation of Helium atoms to the ground level (F_1). Because of long life times of the atoms in levels F_2 and F_3 , this process of energy transfer has a high probability. Thus the discharge through the gas mixture continuously populates the neon atoms in the excited energy levels E_4 and E_6 . This helps to create a state of population inversion between the levels E_4 (E_6) to the lower energy level (E_3 and E_5). The various transitions $E_6 \rightarrow E_5$, $E_4 \rightarrow E_3$, $E_6 \rightarrow E_3$ leads to the emission of wave lengths 3.39mm, 1.15 um and 6328 \AA . Specific frequency selection may be obtained by employing mirrors

The excited Neon atoms drop down from the level E_3 to the E_2 by spontaneously emitting a photon around wavelength 6000\AA . The pressures of the two gases in the mixture are so chosen that there is an effective transfer of energy from the Helium to the Neon atoms. Since the level E_2 is a meta stable state, there is a finite probability of the excitation of Neon, atoms from E_2 to E_3 leading to population inversion, when a narrow tube is used, the neon atoms in the level E_2 collide with the walls of the tube and get excited to the level E_1 . The transition from E_5 to E_3 may be non radioactive. The typical power outputs of He-Ne laser lie between 1 and 50 mw of continuous wave for inputs of 5-10W.

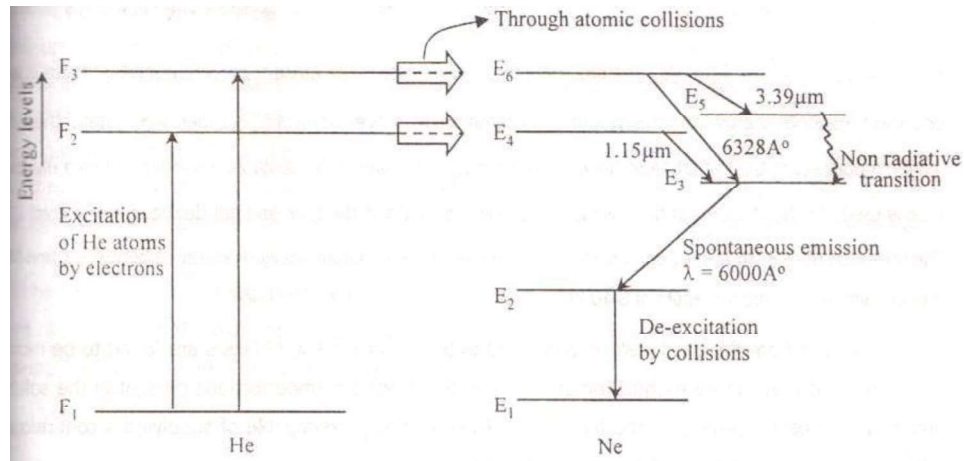

Fig.. Energy level diagram of He-Ne atoms.

Ruby Laser

Ruby Laser is a solid state pulsed, three level lasers. It consists of a cylindrical shaped ruby crystal rod of length varying from 2 to 20cms and diameter varying 0.1 to 2cms. This end faces of the rod are highly flat and parallel. One of the faces is highly silvered and the other face is partially silvered so that it transmits 10 to 25% of incident light and reflects the rest so as to make the rod-resonant cavity. Basically, ruby crystal is aluminum oxide [Al_2O_3] doped with to 0.5% of chromium atom. These chromium atoms serve as activators. Due to presence of 0.05% of chromium, the ruby crystal appears in pink color. The ruby crystal is placed along the axis of a helical xenon or krypton flash lamp of high intensity.

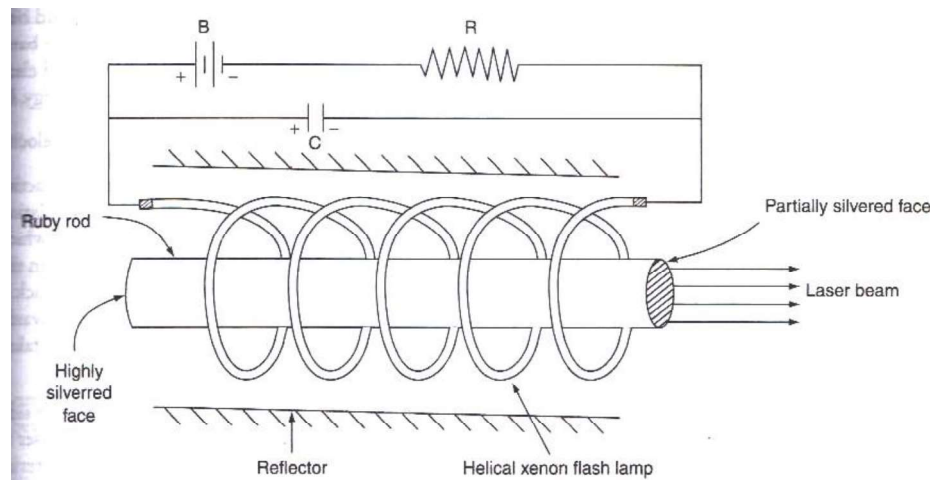

Fig. Ruby laser

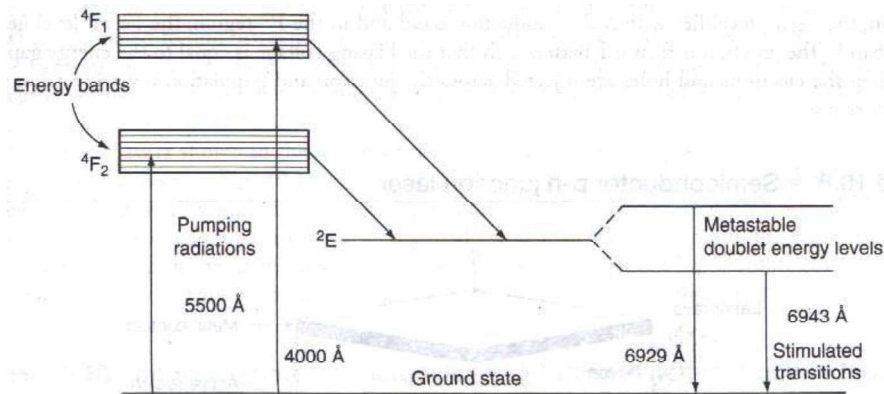

Fig. Energy level diagram of chromium ions in a ruby crystal

Construction:

Ruby ($\text{Al}_2\text{O}_3 + \text{Cr}_2\text{O}_3$) is a crystal of Aluminum oxide in which some of Al^{+3} ions are replaced by Cr^{+3} ions. When the doping concentration of Cr^{+3} is about 0.05%, the color of the rod becomes pink. The active medium in ruby rod is Cr^{+3} ions. In ruby laser a rod of 4cm long and 5mm diameter is used and the ends of the rod are highly polished. Both ends are silvered such that one end is fully reflecting and the other end is partially reflecting.

The ruby rod is surrounded by helical xenon flash lamp tube which provides the optical pumping to raise the Chromium ions to upper energy level (rather energy band). The xenon flash lamp tube which emits intense pulses lasts only few milliseconds and the tube consumes several thousands of joules of energy. Only a part of this energy is used in pumping Chromium ions while the rest goes as heat to the apparatus which should be cooled with cooling arrangements as shown in fig. The energy level diagram of ruby laser is shown in fig.

Working:

Ruby crystal is made up of aluminum oxide as host lattice with small percentage of Chromium ions replacing aluminum ions in the crystal chromium acts as do pant. A do pant actually produces lasing action while the host material sustains this action. The pumping source for ruby material is xenon flash lamp which will be operated by some external power supply. Chromium ions will respond to this flash light having wavelength of 5600\AA . When the Cr^{+3} ions are excited to energy level E_3 from E_1 the population in E_3 increases. Chromium ions stay here for a very short time of the order of 10^{-8} seconds then they drop to the level E_2 which is mat stable state of life time 10^{-3} s. Here the level E_3 is rather a band, which helps the pumping to be more effective. The transitions from E_3 to E_2 are non-radioactive in nature. During this process heat is given to crystal lattice. Hence cooling the rod is an essential feature in this method. The life time in mete stable state is 10^5 times greater than the lifetime in E_3 . As the life of the state E_2 is much longer, the number of ions in this state goes on increasing while ions. In this state goes on increasing while in the ground state (E_1) goes on decreasing. By this process population inversion is achieved between the exited Meta stable state E_2 and the ground state E_1 . When an excited ion passes spontaneously from the metastable state E_2 to the ground state E_1 , it emits a photon of wave length 6943\AA . This photon travels through the rod and if it is moving parallel to the axis of the crystal, is reflected back and forth by the silvered ends until it stimulates an excited ion in E_2 and causes it to emit fresh photon in phase with the earlier photon. This stimulated transition

triggers the laser transition. This process is repeated again and again because the photons repeatedly move along the crystal being reflected from its ends. The photons thus get multiplied. When the photon beam becomes sufficiently intense, such that part of it emerges through the partially silvered end of the crystal.

Drawbacks of ruby laser:

1. The laser requires high pumping power to achieve population inversion.
2. It is a pulsed laser.

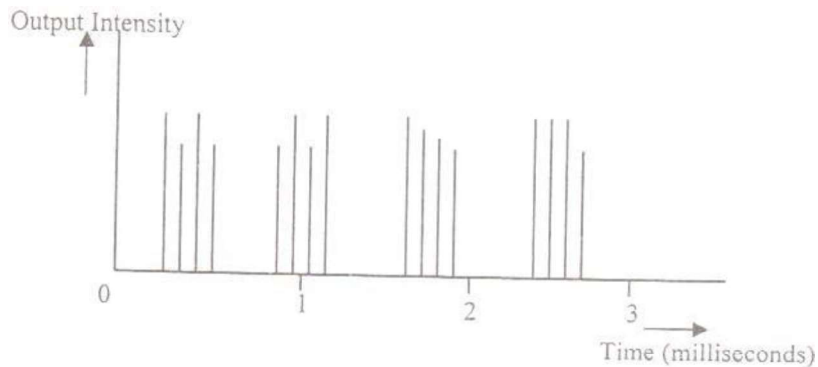

Fig. the output pulses with time.

Applications of Lasers

Lasers find applications in various fields. They are described below.

a) In Communications :

Lasers are used in optical fiber communications. In optical fiber communications, lasers are used as light source to transmit audio, video signals and data to long distances without attenuation and distortion.

- b) The narrow angular spread of laser beam can be used for communication between earth and moon or to satellites.
- c) As laser radiation is not absorbed by water, so laser beam can be used in under water (inside sea) communication networks.

2. Industrial Applications

- a) Lasers are used in metal cutting, welding, surface treatment and hole drilling. Using lasers cutting can be obtained to any desired shape and the curved surface is very smooth.
- b) Welding has been carried by using laser beam.
- c) Dissimilar metals can be welded and micro welding is done with great ease.
- d) Lasers beam is used in selective heat treatment for tempering the desired parts in automobile industry
- e) Lasers are widely used in electronic industry in trimming the components of ICs

3. Medical Applications

1. Lasers are used in medicine to improve precision work like surgery. Brain surgery is an example of precision surgery Birthmarks, warts and discoloring of the skin can easily be

removed with an unfocussed laser. The operations are quick and heal quickly and, best of all, they are less painful than ordinary surgery performed with a scalpel.

2. Cosmetic surgery (removing tattoos, scars, stretch marks, sun spots, wrinkles, birthmarks and hairs) see lasers hair removal.

3. Laser types used in dermatology include ruby(694nm), alexandrite(755nm), pulsed diode array(810nm), Nd:YAG(1064nm), HO:YAG(2090nm), and Er:YAG(2940nm)

4. Eye surgery and refracting surgery.

5. Soft tissue surgery: Co₂ Er :YAG laser.

6. Laser scalpel (general surgery, gynecological, urology, laparoscopic).

7. Dental procedures.

8. Photo bio modulation (i.e. laser therapy)

9. “No-touch” removal of tumors, especially of the brain and spinal cord.

10. In dentistry for caries removal, endodontic/periodontic, procedures, tooth whitening, and oral surgery.

4. Military Applications

The various military applications are:

- a) **Death rays:** By focusing high energetic laser beam for few seconds to aircraft, missile, etc can be destroyed. So, these rays are called death rays or war weapons.
- b) **Laser gun:** The vital part of energy body can be evaporated at short range by focusing highly convergent beam from a laser gun.
- c) **LIDAR (Light detecting and ranging):** In place of RADAR, we can use LIDAR to estimate the size and shape of distant objects or war weapons. The differences between RADAR and LIDAR are that, in case of RADAR, Radio waves are used where as in case of LIDAR light is used.

5. In Computers: By using lasers a large amount of information or data can be stored in CD-ROM or their storage capacity can be increased. Lasers are also used in computer printers.

6. In Thermonuclear fusion: To initiate nuclear fusion reaction, very high temperature and pressure is required. This can be created by concentrating large amount of laser energy in a small volume. In the fusion of deuterium and tritium, irradiation with a high energy laser beam pulse of 1 nano second duration develops a temperature of 10^{17} °c, this temperature is sufficient to initiate nuclear fusion reaction.

7. In Scientific Research: In scientific, lasers are used in many ways including

- a) A wide variety of interferometric techniques.
- b) Raman spectroscopy.
- c) Laser induced breakdown spectroscopy.
- d) Atmospheric remote sensing.
- e) Investigating non linear optics phenomena
- f) Holographic techniques employing lasers also contribute to a number of measurement techniques.
- g) Laser (LADAR) technology has application in geology, seismology, remote sensing and atmospheric physics.
- h) Lasers have been used aboard spacecraft such as in the cassini-huygens mission.
- i) In astronomy lasers have been used to create artificial laser guide stars, used as reference objects for adaptive optics telescope.

FIBER OPTICS

Introduction

1. An optical fiber (or fiber) is a glass or plastic fiber that carries light along its length.
2. Fiber optics is the overlap of applied science and engineering concerned with the design and application of optical fibers.
3. Optical fibers are widely used in fiber-optic communications, which permits transmission over long distances and at higher band widths (data rates) than other forms of communications.
4. Specially designed fibers are used for a variety of other applications, including sensors and fiber lasers. Fiber optics, though used extensively in the modern world, is a fairly simple and old technology.

Principle of Optical Fiber

Optical fiber is a cylinder of transparent dielectric medium and designed to guide visible and infrared light over long distances. Optical fibers work on the principle of **total internal reflection**.

Optical fiber is very thin and flexible medium having a cylindrical shape consisting of three sections

- 1) The core material
- 2) The cladding material
- 3) The outer jacket

The structure of an optical is shown in figure. The fiber has a core surrounded by a cladding material whose reflective index is slightly less than that of the core material to satisfy the condition for total internal reflection. To protect the fiber material and also to give mechanical support there is a protective cover called outer jacket. In order to avoid damages there will be some cushion between cladding protective cover.

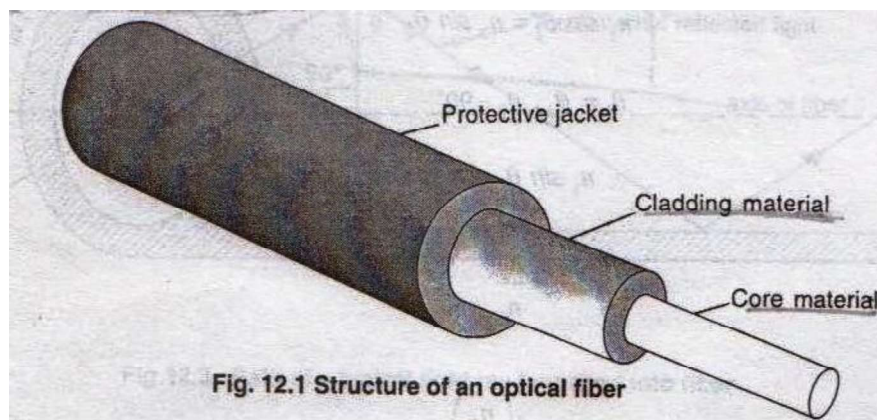

Fig..Structure of an optical fiber

When a ray of light passes from an optically denser medium into an optically rarer medium the refracted ray bends away from the normal. When the angle of incidence is increased angle of refraction also increases and a stage is reached when the refracted ray just grazes the surface of separation of core and cladding. At this position the angle of refraction is 90 degrees.

This angle of incidence in the denser medium is called the **critical angle (θ_c)** of the denser medium with respect to the rarer medium and is shown in the fig. If the angle of incidence is further increased then the ray is totally reflected. This is called total **internal reflection**. Let the refractive indices of core and cladding materials be n_1 and n_2 respectively.

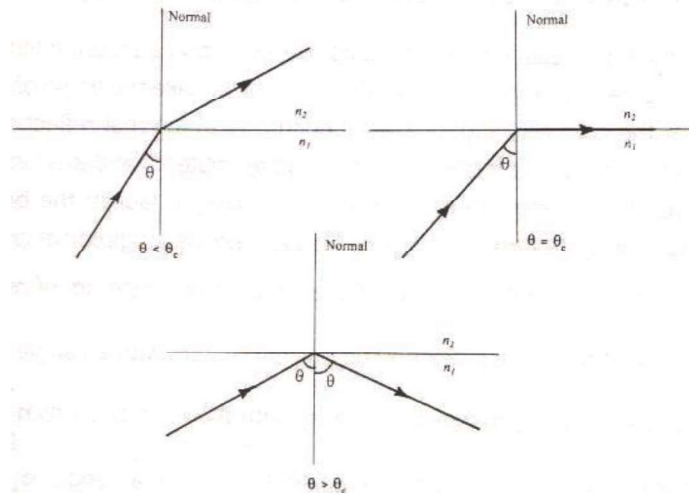

Fig. Total internal reflection.

When a light ray, travelling from an optically denser medium into an optically rarer medium is incident at angle greater than the critical angle for the two media. The ray is totally reflected back into the medium by obeying the law of reflection. This phenomenon is known as totally internal reflection.

According to law of refraction,

$$n_1 \sin\theta_1 = n_2 \sin\theta_2$$

Here $\theta_1 = \theta_c$, $\theta_2 = 90^\circ$

$$n_1 \sin \theta_c = n_2 \sin 90$$

$$\sin\theta_c = \frac{n_2}{n_1}$$

$$\theta_c = \sin^{-1}\left(\frac{n_2}{n_1}\right) \quad \rightarrow(1)$$

Equation (1) is the expression for condition for total internal reflection. In case of total internal reflection, there is absolutely no absorption of light energy at the reflecting surface. Since the entire incident light energy is returned along the reflected light it is called total internal reflection. As there is no loss of light energy during reflection, hence optical fibers are designed to guide light wave over very long distances.

Acceptance Angle and Acceptance Cone

Acceptance angle: It is the angle at which we have to launch the beam at its end to enable the entire light to propagate through the core. Fig.8.12 shows longitudinal cross section of the launch of a fiber with a ray entering it. The light is entered from a medium of refractive index n_0 (for air $n_0=1$) into the core of refractive index n_1 . The ray (OA) enters with an angle of incidence to the fiber end face i.e. the incident ray makes angle with the fiber axis which is nothing but the

normal to the end face of the core. Let a right ray OA enters the fiber at an angle to the axis of the fiber. The end at which light enters the fiber is called the **launching pad**.

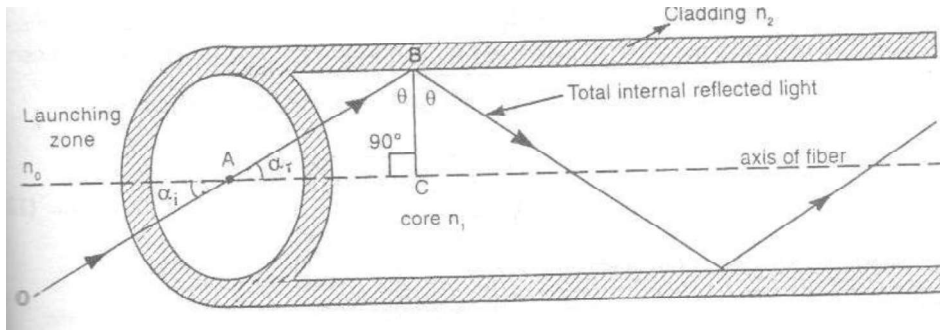

Fig. Path of atypical light ray launched into fiber.

Let the refractive index of the core be n_1 and the refractive index of cladding be n_2 . Here $n_1 > n_2$. The light ray reflects at an angle and strikes the core cladding interface at angle θ . If the angle θ is greater than its critical angle θ_c , the light ray undergoes total internal reflection at the interface.

According to Snell's law

$$n_0 \sin \alpha_i = n_1 \sin \alpha_r \quad \rightarrow (2)$$

From the right angled triangle ABC

$$\alpha_r + \theta = 90^\circ$$

$$\alpha_r = 90^\circ - \theta \quad \rightarrow (3)$$

Substituting (3) in (2), we get

$$n_0 \sin \alpha_i = n_1 \sin (90^\circ - \theta) = n_1 \cos \theta$$

$$\sin \alpha_i = \left(\frac{n_1}{n_0} \right) \cos \theta \quad \rightarrow (4)$$

When $\theta = \theta_c$, $\alpha_i = \alpha_m = \text{maximum } \alpha \text{ value}$

$$\sin \alpha_m = \left(\frac{n_1}{n_0} \right) \cos \theta_c \quad \rightarrow (5)$$

From equation (1) $\sin \theta_c = \frac{n_2}{n_1}$

$$\cos \theta_c = 1 - \sin^2 \theta_c = 1 - \left(\frac{n_2}{n_1} \right)^2 = \frac{n_1^2 - n_2^2}{n_1} \quad \rightarrow (6)$$

Substitute equation (6) in equation (5)

$$\sin \alpha_m = \left(\frac{n_1}{n_0} \right) \frac{n_1^2 - n_2^2}{n_1} = \frac{n_1^2 - n_2^2}{n_0} \quad \rightarrow (7)$$

If the medium surrounding fiber is air, then $n_0 = 1$

$$\sin \alpha_m = \frac{n_1^2 - n_2^2}{n_0} \quad \rightarrow (8)$$

This maximum angle is called the **acceptance angle or the acceptance cone half angle** of the fiber.

The **acceptance angle** may be defined as the maximum angle that a light ray can have with the axis of the fiber and propagate through the fiber. Rotating the acceptance angle about the fiber axis (fig.) describes the acceptance cone of the fiber. Light launched at the fiber end within this acceptance cone alone will be accepted and propagated to the other end of the fiber by total internal reflection. Larger acceptance angles make launching easier. Light gathering capacity of the fiber is expressed in terms of maximum acceptance angle and is termed as “**Numerical Aperture**”.

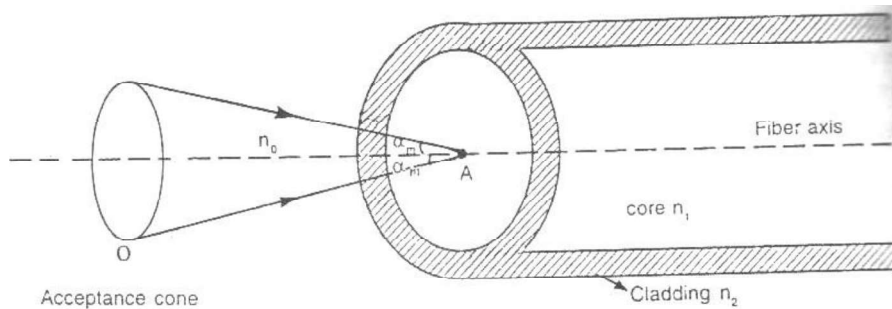

Fig. Acceptance cone

Numerical Aperture

Numerical Aperture of a fiber is measure of its light gathering power. The numerical aperture (NA) is defined as the sign of the maximum acceptance angle.

$$\text{Numerical aperture (NA)} = \sin \alpha_m = \sqrt{n_1^2 - n_2^2} \quad \rightarrow (9)$$

$$= \frac{(n_1 - n_2)(n_1 + n_2)}{((n_1 + n_2) n_1 \Delta)} \quad \rightarrow (10)$$

Where $\Delta = \frac{(n_1^2 - n_2^2)}{n_1^2}$ called as fractional differences in refractive indices n_1 and n_2 are the refractive indices of core and cladding material respectively.

As $n_1 \approx n_2$, we can take $n_1 + n_2 = 2n_1$

$$\text{Then numerical aperture} = (2n_1^2 \Delta)^{1/2} = n_1 (2\Delta)^{1/2} \rightarrow (11)$$

Numerical aperture is a measure of amount of light that can be accepted by a fiber. From equation (9) it is seen that numerical aperture depends only on the refractive indices of core and cladding materials and it is independent on the fiber dimensions. Its value ranges from 0.1 to 0.5. A large NA means that the fiber will accept large amount of light from the source.

Proof:

We shall show that the light emitted by a small defuse source situated on the fiber axis near to one end face, only a fraction NA^2 can be collected by the fiber and propagated along the fiber. Consider a small defuse light source such as the isotropic radiator in which the power radiated per unit solid angle in a direction θ to the normal to the surface

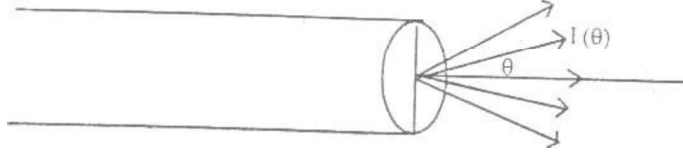

is given by

Fig. Diffuse light source

$$I(\theta) = I_0 \cos \theta \rightarrow (12)$$

The total power φ_0 emitted such source is obtained by integrating $I(\theta)$ over all forward directions

$$\varphi_0 = \int_0^{\pi/2} I_0 \cos \theta d\theta \rightarrow (13)$$

Where $d\Omega = \text{small element of solid angle} = 2\pi \sin \theta d\theta \rightarrow (14)$

$$\begin{aligned} \varphi_0 &= \int_0^{\pi/2} I_0 \cos \theta 2\pi \sin \theta d\theta \\ &= \int_0^{\pi/2} \pi I_0 \sin 2\theta d\theta = \pi I_0 \end{aligned} \rightarrow (15)$$

But the power from such source that can be collected by an adjacent fiber whose core diameter is greater than the diameter of the source is given by Φ , where

$$\begin{aligned} \Phi &= \int_0^{\alpha_m} I_0 \cos \theta 2\pi \sin \theta d\theta \\ &= \pi I_0 \sin 2\alpha_m \end{aligned}$$

$$(\Phi / \varphi_0) = (\sin \alpha_m)^2 = (NA)^2 = 2n_1^2 \Delta \rightarrow (16)$$

Where $\Delta = \frac{(n_1^2 - n_2^2)}{n_1^2}$

Equation (16) represents the light gathering power of the fiber. In order to collect as much light as possible it is necessary to make n_1 and Δ large.

In some cases it is customary to use Δn which can be defined as $\Delta n = n_1 - n_2$

But $\Delta = \frac{(n_1 - n_2)}{n_1} = \frac{\Delta n}{n_1}$

$$(\Phi / \varphi_0) = (\sin \alpha_m)^2 = (NA)^2 = 2n_1 \Delta n \rightarrow (17)$$

$$NA = (2n_1 \Delta n) \rightarrow (18)$$

Step index fibers and graded index fiber -transmission of signals in them:

Based on the variation of refractive index of core, optical fibers are divided into: (1) step index and (2) graded index fibers. Again based on the mode of propagation, all these fibers are divided into: (1) single mode and (2) multimode fibers. In all optical fibers, the refractive index of cladding material is uniform. Now, we will see the construction, refractive index of core and cladding with radial distance of fiber, ray propagation and applications of above optical fibers.

- i. **Step index fiber:** The refractive index is uniform throughout the core of this fiber. As we go radially in this fiber, the refractive index undergoes a step change at the core-cladding interface. Based on the mode of propagation of light rays, step index fibers are of 2 types: a) single mode step index fiber & b) multimode step index fibers. Mode means, the number of paths available for light propagation of fiber. We describes the different types of fiber below

- a) **Single mode step index fiber:** The core diameter of this fiber is about 8 to $10\mu\text{m}$ and outer diameter of cladding is 60 to $70\mu\text{m}$. There is only one path for ray

propagation. So, it is called **single mode fiber**. The cross sectional view, refractive index profile and ray propagation are shown in fig. (i). In this fiber, the transmission of light is by successive total internal reflections i.e. it is a reflective type fiber. Nearly 80% of the fibers manufactured today in the world are single mode fibers. So, they are extensively used.

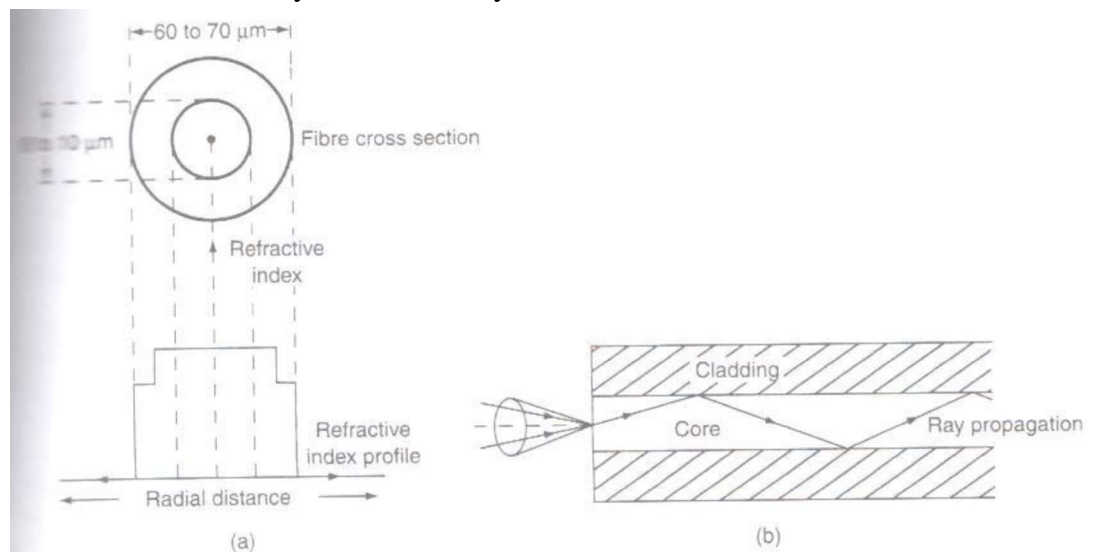

Fig (i).Single mode step index fiber ;(a) Cross sectional view and refractive index profile ;(b) Ray propagation

Multimode step index fiber: The construction of multimode step index fiber is similar to single mode step index fiber except that its core and cladding diameters are much larger to have many paths for light propagation. The core diameter of this fiber varies from 50 to 200 μm and the outer diameter of cladding varies from 100 to 250 μm . The cross-sectional view, refractive index profile and ray propagations are shown in fig 2. Light propagation in this fiber is by multiple total internal reflections i.e it is a reflective type fiber.

- b) **Transmission of signal in step index fiber:** Generally the signal is transmitted through the fiber in digital form i.e. in the form of 1's and 0's. The propagation of pulses through the multimode fiber is shown in fig (i)(b). The pulse which travels along path 1(straight) will reach first at the other end of fiber. Next the pulse that travels along with path 2(zig-zag) reaches the other end. Hence, the pulsed signal received at the other end is broadened. This is known as intermodal dispersion. This imposes limitation on the separation between pulses and reduces the transmission rate and capacity. To overcome this problem, graded index fibers are used.

2) **Graded index fiber:** In this fiber, the refractive index decreases continuously from center radially to the surface of the core. The refractive index is maximum at the center and minimum at the surface of core. This fiber can be single mode or multimode fiber. The cross sectional view,

refractive index profile and ray propagation of multimode graded index fiber are shown in fig .(ii)(a). The diameter of core varies from 50 to 200 μm and outer diameter of cladding varies from 100 to 250 μm .

The refractive index profile is circularly symmetric. As refractive index changes continuously radially in core, light rays suffer continuous refraction in core. The propagation of light ray is not due to total internal reflection but by refraction as shown in fig. (ii)(b). in graded index fiber, light rays travel at different speed in different paths of the fiber. Near the surface of the core, the refractive index is lower, so rays near the outer surface travel faster than the rays travel at the center. Because of this, all the rays arrive at the receiving end of the fiber approximately at the same time. This fiber is costly. .

Transmission of signal graded index fiber: In multimode graded index fiber, large number of paths is available for light ray propagation. To discuss about inter modal dispersion, we consider ray path 1 along the axis of fiber.

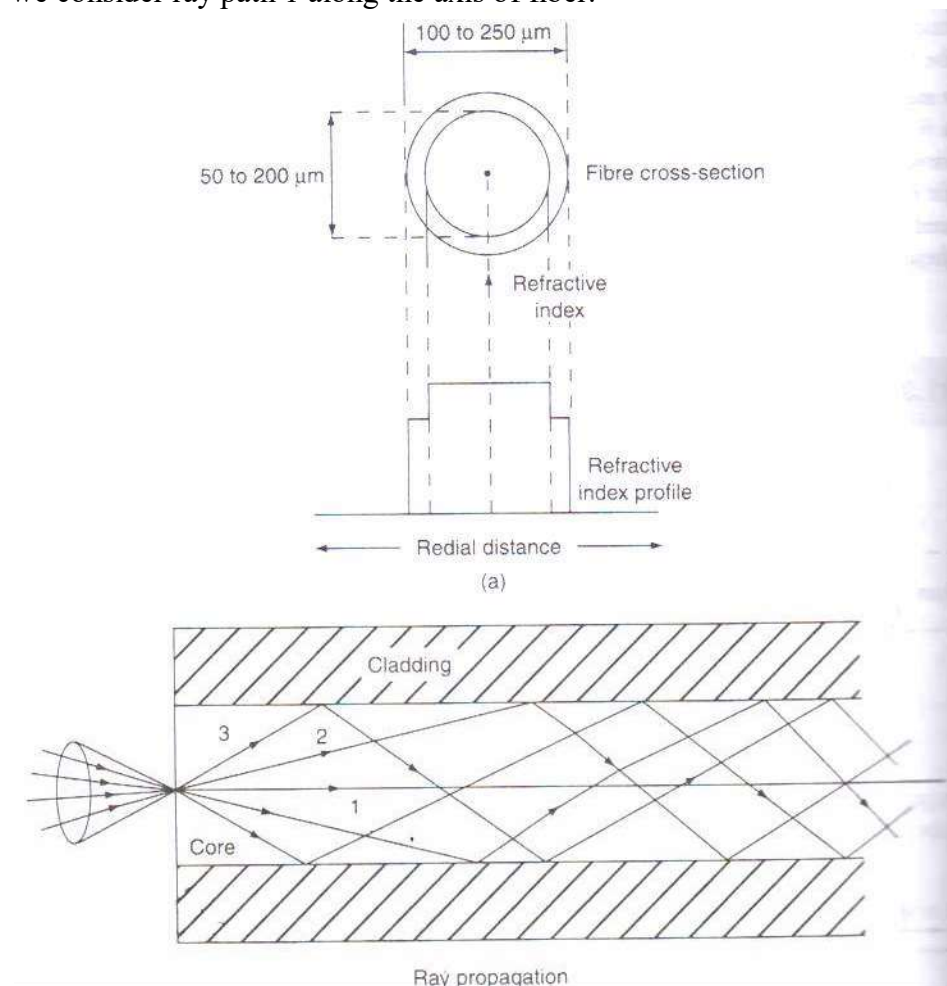

Fig. (ii).Multimode step index fibre(a)Cross sectional view and refractive index profile(b)Ray propagation

As shown in fig. (ii)(b) and another ray path 2. Along with the axis of fiber, the refractive index of core is maximum, so the speed of ray along path 1 is less. Path 2 is sinusoidal and it is longer, along this path refractive index varies. The ray mostly travels in low refractive region, so the ray 2 moves slightly faster. Hence, the pulses of signals that travel along path 1 and path 2 reach

other end of fiber simultaneously. Thus, the problem of intermodal dispersion can be reduced to a large extent using graded index fibers.

Differences between step index fiber and graded index fibers:

Step index fiber	Graded index fiber
1. The refractive index of core is uniform and step or abrupt change in refractive index takes place at the interface of core and cladding in step index fibers	1. The refractive index of core is non uniform, the refractive index of core decreases Parabolicity from the axis of the fiber to its surface.
2. The light rays propagate in zigzag manner inside the core. The rays travel in the fiber as meridional rays they cross the fiber axis for every reflection.	2. Light rays propagate in the form of skew rays or helical rays. They will not cross the fiber axis

Difference between single mode fibers and multi mode fibers:

Single mode fiber	Multimode fiber
1. In single mode fiber there is only one path for ray propagation	1. In multimode fiber, large number of paths is available for light ray propagation.
2. A single mode step index fiber has less core diameter ($< 10 \mu\text{m}$) and the difference between the refractive indices of core and cladding is very small.	2. Multimode fibers, large number of paths are available for light ray propagation.
3. In single mode fibers, there is no dispersion.	3. There is signal distortion and dispersion takes place in multimode fibers.
4. The bandwidth is about 50 MHz for multimode step index fiber whereas it is more than 1000 MHz km in case of single mode step index fiber.	4. The bandwidth of the fiber lies in between 200 MHz km to 600 MHz km even though theoretically it has an infinite bandwidth.
5. NA of multimode step index fiber is more whereas in single mode step index fibers, it is very less.	5. NA of graded index fibers is less.
6. Launching of light into single mode fibers is difficult.	6. Launching of light into multimode fibers is easy.
7. Fabrication cost is very high.	7. Fabrication cost is less

Fiber optic communication system :

Fiber optics essentially deals with the communication (including voice signals, video signals or digital data) by transmission of light through optical fibers. Optical fiber communication system essentially consists of three parts: (a) transmitter (b) optical fiber and (c) receiver. The transmitter includes modulator, encoder, light source, drive circuits and couplers. The receiver includes amplifier and decoder, binary electrical signal and light decoder.

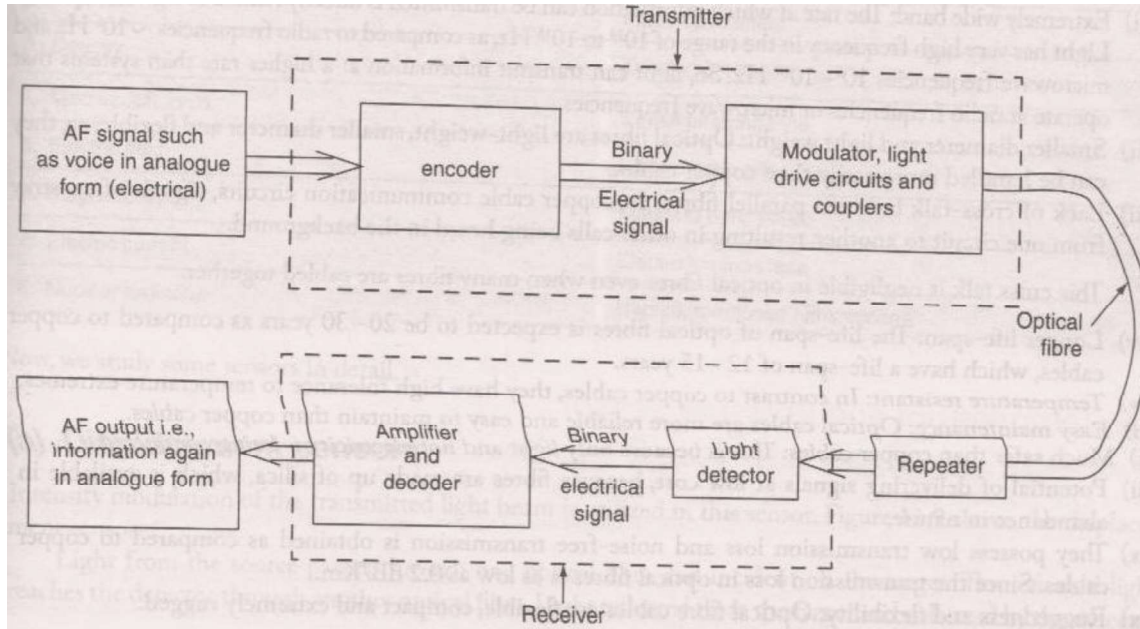

Fig. Block diagram represents optical fibre communication system

